

INVESTIGATION OF THE FEASIBILITY  
OF FABRICATING SPECIAL  
THERMOLUMINESCENT DOSIMETER MATERIALS

A Thesis

Submitted to the Graduate Faculty of the  
Louisiana State University and  
Agricultural and Mechanical College  
in partial fulfillment of the  
requirements for the degree of

Master of Science

in

The Department of Nuclear Engineering

by

Russell Timothy Kracht  
B.S., Louisiana State University, 1973

December, 1975

DEDICATED TO  
my wife, Debbie

### ACKNOWLEDGEMENT

The author would like to express his sincere appreciation to his major professor, Dr. Robert C. McIlhenney, for his assistance, encouragement, and advice during the preparation of this work.

The author is thankful to Dr. John Courtney, Dr. Robert Miles, and Dr. Dupree Maples for their helpful advice and Calvin Joseph Bergeron for his invaluable encouragement.

To his wife, Debbie, the author wishes to express his sincere appreciation of the time spent typing this thesis. A special word of thanks is given for the encouragement given by her.

TABLE OF CONTENTS

	PAGE
ACKNOWLEDGEMENT . . . . .	iii
LIST OF TABLES . . . . .	v
LIST OF FIGURES . . . . .	vi
<hr/>	
ABSTRACT . . . . .	ix
CHAPTER	
I. Introduction . . . . .	1
II. Experimental Equipment and Procedures . . . . .	6
Fabrication of Pelletizing Equipment. . . . .	6
Additional Pellet Production Equipment. . . . .	8
General Pressing Procedures . . . . .	10
Irradiation Assembly. . . . .	12
Exposure and Reading Procedures . . . . .	15
III. Results . . . . .	17
IV. Discussion. . . . .	46
Mechanics of Pellet Production. . . . .	46
TLD Readout Technique . . . . .	49
Pellet Radiation Exposure . . . . .	56
Determination of Optimum Pressing Parameters. . . . .	57
Reagent Grade Calcium Fluoride . . . . .	58
Reagent Grade Lithium Fluoride and Lithium Fluoride/ Calcium Fluoride Mixture Pellets. . . . .	63
V. Conclusions . . . . .	66
REFERENCES . . . . .	68
VITA . . . . .	69

LIST OF TABLES

TABLE		PAGE
4.1	A List of Data Plotted in Figure 4.6, Figure 4.7, and Figure 4.8 . . . . .	62
4.2	Calcium Fluoride and Lithium Fluoride Pellet Densities . . . . .	64

## LIST OF FIGURES

FIGURE		PAGE
1.1	Schematic Energy-Level Diagram of an Insulating Crystal which Exhibits TL due to Radiation . . . . .	2
2.1	Die Assembly Dimensions. . . . .	7
2.2	Schematic Diagram of Experimental Systems. . . . .	9
2.3	Irradiation Assembly . . . . .	13
2.4	Pellet Exposure Layout . . . . .	14
3.1	Plot of Response versus Indicated Dose for CaF <sub>2</sub> at 150° C and 1.0 ton . . . . .	19
3.2	Plot of Response versus Indicated Dose for CaF <sub>2</sub> at 150° C and 1.5 tons. . . . .	20
3.3	Plot of Response versus Indicated Dose for CaF <sub>2</sub> at 150° C and 2.0 tons. . . . .	21
3.4	Plot of Response versus Indicated Dose for CaF <sub>2</sub> at 200° C and 1.0 ton . . . . .	22
3.5	Plot of Response versus Indicated Dose for CaF <sub>2</sub> at 200° C and 1.5 tons. . . . .	23
3.6	Plot of Response versus Indicated Dose for CaF <sub>2</sub> at 200° C and 2.0 tons. . . . .	24
3.7	Plot of Response versus Indicated Dose for CaF <sub>2</sub> at 300° C and 1.0 ton . . . . .	25
3.8	Plot of Response versus Indicated Dose for CaF <sub>2</sub> at 300° C and 1.5 tons. . . . .	26
3.9	Plot of Response versus Indicated Dose for CaF <sub>2</sub> at 300° C and 2.0 tons. . . . .	27
3.10	Plot of Response versus Indicated Dose for CaF <sub>2</sub> at 400° C and 1.0 ton . . . . .	28
3.11	Plot of Response versus Indicated Dose for CaF <sub>2</sub> at 400° C and 1.5 tons. . . . .	29

LIST OF FIGURES (CONT'D.)

FIGURE	PAGE
3.12 Plot of Response versus Indicated Dose for CaF <sub>2</sub> at 400° C and 2.0 tons . . . . .	30
3.13 Plot of Response versus Indicated Dose for LiF at 150° C and 1.0 ton . . . . .	31
3.14 Plot of Response versus Indicated Dose for LiF at 150° C and 1.5 tons . . . . .	32
3.15 Plot of Response versus Indicated Dose for LiF at 150° C and 2.0 tons . . . . .	33
3.16 Plot of Response versus Indicated Dose for LiF at 200° C and 1.0 ton . . . . .	34
3.17 Plot of Response versus Indicated Dose for LiF at 200° C and 1.5 tons . . . . .	35
3.18 Plot of Response versus Indicated Dose for LiF at 200° C and 2.0 tons . . . . .	36
3.19 Plot of Response versus Indicated Dose for LiF at 300° C and 1.0 ton . . . . .	37
3.20 Plot of Response versus Indicated Dose for LiF at 300° C and 1.5 tons . . . . .	38
3.21 Plot of Response versus Indicated Dose for LiF at 300° C and 2.0 tons . . . . .	39
3.22 Plot of Response versus Indicated Dose for LiF at 400° C and 1.0 ton . . . . .	40
3.23 Plot of Response versus Indicated Dose for LiF at 400° C and 1.5 tons . . . . .	41
3.24 Plot of Response versus Indicated Dose for LiF at 400° C and 2.0 tons . . . . .	42
3.25 Plot of Response versus Indicated Dose for 25% - LiF, 75% - CaF <sub>2</sub> at 300° C and 1.5 tons . . . . .	43
3.26 Plot of Response versus Indicated Dose for 50% - LiF, 50% - CaF <sub>2</sub> at 300° C and 1.5 tons . . . . .	44
3.27 Plot of Response versus Indicated Dose for 75% - LiF, 25% - CaF <sub>2</sub> at 300° C and 1.5 tons . . . . .	45

LIST OF FIGURES (CONT'D.)

FIGURE	PAGE
4.1 Typical Commercial LiF Glow Curve (Dose approximately 0.9R) . . . . .	51
4.2 Typical LiF Pressed Pellet Glow Curve (Dose approximately 8.0R) . . . . .	52
4.3 Glow Curve from a Pellet Pressed from TLD 100 Powder (Dose approximately 1.0R) . . . . .	53
4.4 Typical CaF <sub>2</sub> Pressed Pellet Glow Curve (Dose approximately 6.0R) . . . . .	54
4.5 Typical Commercial CaF <sub>2</sub> Glow Curve (Dose approximately 1.5R) . . . . .	55
4.6 Three Dimensional Plot of TL Output versus Temperature and Pressure . . . . .	59
4.7 Three Dimensional Plot of Linear Deviation versus Temperature and Pressure. . . . .	60
4.8 Three Dimensional Plot of TL Output/Linear Deviation versus Temperature and Pressure. . . . .	61
4.9 TL Response Variation as a Function of LiF/CaF <sub>2</sub> Mixture Composition . . . . .	65



## ABSTRACT

Thermoluminescent dosimeters have been commercially available in convenient form for several years as hot-pressed chips. Recently, new materials with special properties have been reported, but currently are available as powders. The feasibility of pelletizing powders with simple equipment was investigated with two reagent-grade materials (lithium fluoride and calcium fluoride) singly and in combination. Successful pellets which exhibited radiation induced thermoluminescence were produced from calcium fluoride at pressures of 40,700 to 81,400 pounds per square inch and temperatures of 200° C to 300° C. These pellets also had good mechanical integrity. Mechanically acceptable lithium fluoride and lithium fluoride/calcium fluoride pellets were produced, but they were unsatisfactory as dosimeter materials. All thermoluminescent responses were obtained with a Victoreen model 2800 reader system used in factory-set heating modes, which were not optimum for the pellets produced in this study. Improved response would be expected through external temperature programming and with materials specifically synthesized for thermoluminescent behavior.

## CHAPTER I

### Introduction\*

Thermoluminescence (TL) is a phenomenon that has been observed for some time. The relation of TL to X-rays or gamma rays was observed by Curie<sup>3</sup> (1904), Wick<sup>4</sup> (1927), and Lyman<sup>5</sup> (1935), but was not suggested for use as a radiation dosimeter until Daniels<sup>6</sup> developed equipment for this purpose in 1950. Although the theory behind thermoluminescence is not fully understood at the present time, several hypothetical models have been proposed to explain the process. The simplest model for TL behavior has been adopted for the following discussion.

Figure 1.1 (a) represents the TL material during exposure. The ionizing radiation interacts with the phosphor, leading indirectly to a transfer of electrons from the valence band to the conduction band through the increase in energy. This leaves electron holes in the valence band. Since electrons and holes can move freely through the TL material most recombine. Some, however, are trapped in higher energy levels or so called metastable states. These electron traps are assumed to be associated with defects in the crystal structure such as impurity sites and dislocations. Two possible ways exist for light to be emitted. During the heating process, enough thermal energy may be transferred to the trapped electron to raise it back into conduction band. From here it

---

\*The material discussed in this Section is obtained in part from Solid State Dosimetry<sup>1</sup>, and from Thermoluminescent Dosimetry<sup>2</sup>.

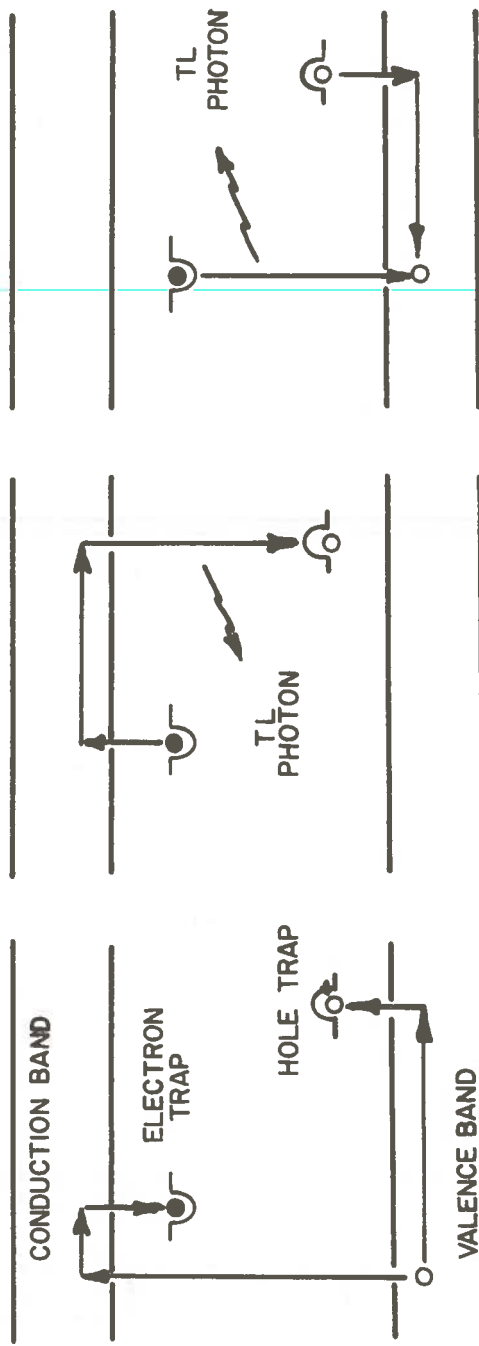

(a) Exposure to ionizing radiation.

(b) Heating: Electron trap is less stable, hole trap is the emitting center.

(c) Heating: Hole trap is less stable, electron trap is the emitting center.

Figure 1.1.--Schematic energy-level diagram of an insulating crystal which exhibits TL due to radiation.

can be either retrapped or recombine with a trapped hole. If the latter results, a TL photon is emitted. An alternate case could result if the hole trap is less stable than the electron trap. During heating, the hole would receive enough energy to combine with the trapped electron, and again TL light would be released.<sup>7</sup>

When the thermal energy transferred to the crystal is equal to or greater than the energy gap between the valence band and the conduction band, any trapped electrons or holes are assured of being released. In other words, the probability for light emission increases to one with increasing temperature. The rise in probability can be observed graphically when a plot is made of TL light output versus material temperature. The plot, called a glow curve, starts at the zero level, increases to a maximum value at a specific temperature, and then decreases again to zero.

Because the quantity of light emitted upon heating an irradiated TL material is proportional to the amount of absorbed energy, the TL process is useful in the field of radiation dosimetry. At present, several companies manufacture thermoluminescent dosimeter (TLD) materials in the form of loose powders, extruded ribbons, and hot pressed chips. Lithium fluoride and calcium fluoride hot pressed chips have won wide acceptance in recent years for a number of reasons. These reasons include:

1. No dependence on dose rate
2. Small size
3. Needs no packaging
4. Useful range of 1 mR to  $10^5$  R
5. LiF almost tissue equivalent
6. Reusable
7. Sensitivity almost constant for energies above 300 KeV

8. Retains information for long periods

9. Approximates a point detector

There are many other promising TLD materials available, such as  $\text{LiB}_4\text{O}_7$ ,  $\text{BeO}$ ,  $\text{Al}_2\text{O}_3$ , and  $\text{CaSO}_4$  to name just a few. These, however, are in powdered form and not easily applied to dosimetric use. The problem of using powders is three fold;

1. Precise amounts must be weighed and packaged for use,
2. Sample loss is possible during irradiation and reading procedures, and
3. Dust or other contamination is easily picked up and difficult to remove.

A preferable configuration would be one in which the dosimeter material is compacted into pellet form. Weighing and sample loss would no longer be a problem and contamination would be minimized. Present TLD's ( $\text{LiF}$  and  $\text{CaF}_2$ ) in hot pressed chips form work well, but are relatively expensive and are not locally available.

The desirability of fabricating TLD pellets should be evident because of limited availability, expense, and the value of providing alternate configurations. Once procedures are developed for pelletizing, a large variety of TLD materials could be studied and evaluated using equipment already available at the Louisiana State University Nuclear Science Center. When suitable materials are found they could then be employed for limited department use.

The two most recent books on thermoluminescence, and a review of the literature of the past fifteen years on TL material fabrication revealed nothing on the actual pelletizing process.

This investigation addresses itself to developing techniques for pelletizing the TLD powders and studying some of the properties of pellets fabricated from commercial reagent grade calcium fluoride and lithium fluoride powders.

## CHAPTER II

### Experimental Equipment and Procedures

Details of the fabrications of pelletizing equipment, and the procedure employed for pressing, irradiating, and reading formed thermoluminescence dosimeter discs are described in this chapter. Necessary equipment included the die body and plunger, hydraulic press, heating oven, radiation source and sample holder, thermoluminescence reader, and a disc-annealing oven. Each of these items will be described or identified.

#### Fabrication of Pelletizing Equipment

The die body was machined from a section of 2 1/4 x 2 1/4 316 stainless steel bar stock. It was drilled axially and reamed to 1/4 inch. Both ends of the die body were then faced in a lathe to insure that they were parallel and perpendicular to the bore.

This die body fulfilled two design criteria. One, it was resistant to the effects of high temperatures, in that the surface oxidation was slight. The second being, that it was massive enough that the temperature fluctuation at the center would be slow when it was removed from the oven.

The die plungers were machined from twist drills. By using twist drill shanks, much machining time was saved since the diameter was the exact size required. In addition, the drill shanks made from high-carbon or high-speed steels were capable of sustaining the high compressive loads and elevated temperatures with only minimal deformation.

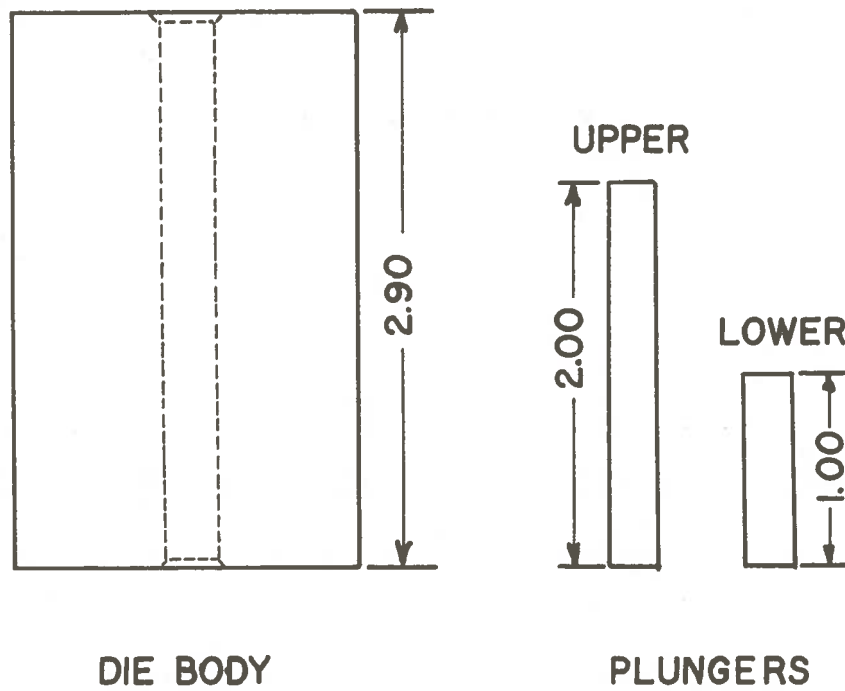
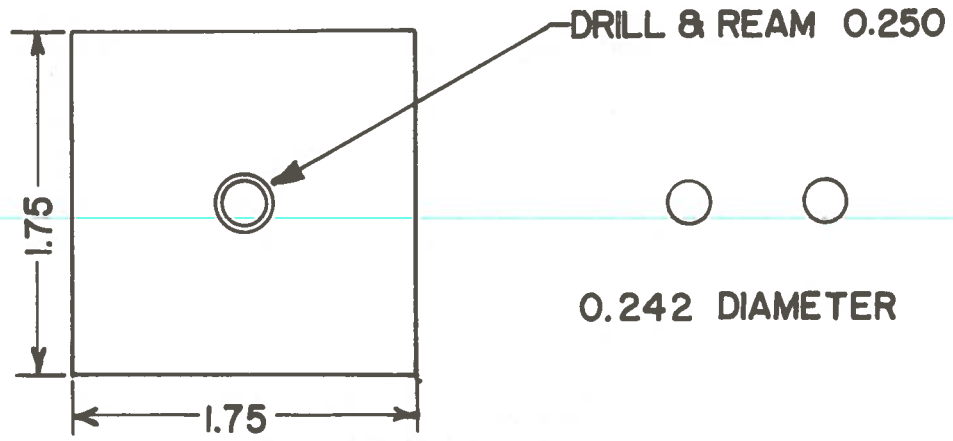

Figure 2.1

Die Assembly Dimensions



Because of the hardness of the drill bits, machining was difficult. In order to cut a drill shank to the required length, it was first necessary to grind a wedge-shaped cut, approximately three-fourths the diameter of the drill, between the shank and flutes. The shank could then be separated easily by supporting the shank in a vise and administering a blow radially to the flutes. The shank was then ground flat on each end to the approximate plunger length. Facing the shank ends with a lathe brought it to the final plunger length and insured that the faces were perpendicular to the sides. One end of the shank was chosen arbitrarily as the plunger compression face. A three step polishing process was employed to finish the face surface. While the plunger was still chucked in the lathe and turning, emery cloth was used to remove any rough edges. The second step, after removing the plunger from the lathe, involved shining the face still further using 400 and 600 grit silicon carbide sandpaper in succession. Finally, the face was polished to a mirror finish using a polishing wheel and liberal amounts of jewelers rouge. The resulting finish provided a relatively non-stick plunger face. This face, however, required repolishing after almost every use when subjected to temperatures above 300° C.

To overcome this problem, a set of plungers were chromium plated. These plungers were used successfully at temperatures up to 400° C.

#### Additional Pellet Production Equipment

Heating the die was accomplished with a Harshaw Scientific oven. The temperature was controlled using a General Radio Company Variac Adjustable Transformer, Model 100-R, capable of delivering a current of 17 amperes at 115 volts. Oven temperature was monitored with a Thermo Electric Manufacturing Company thermocouple gauge.

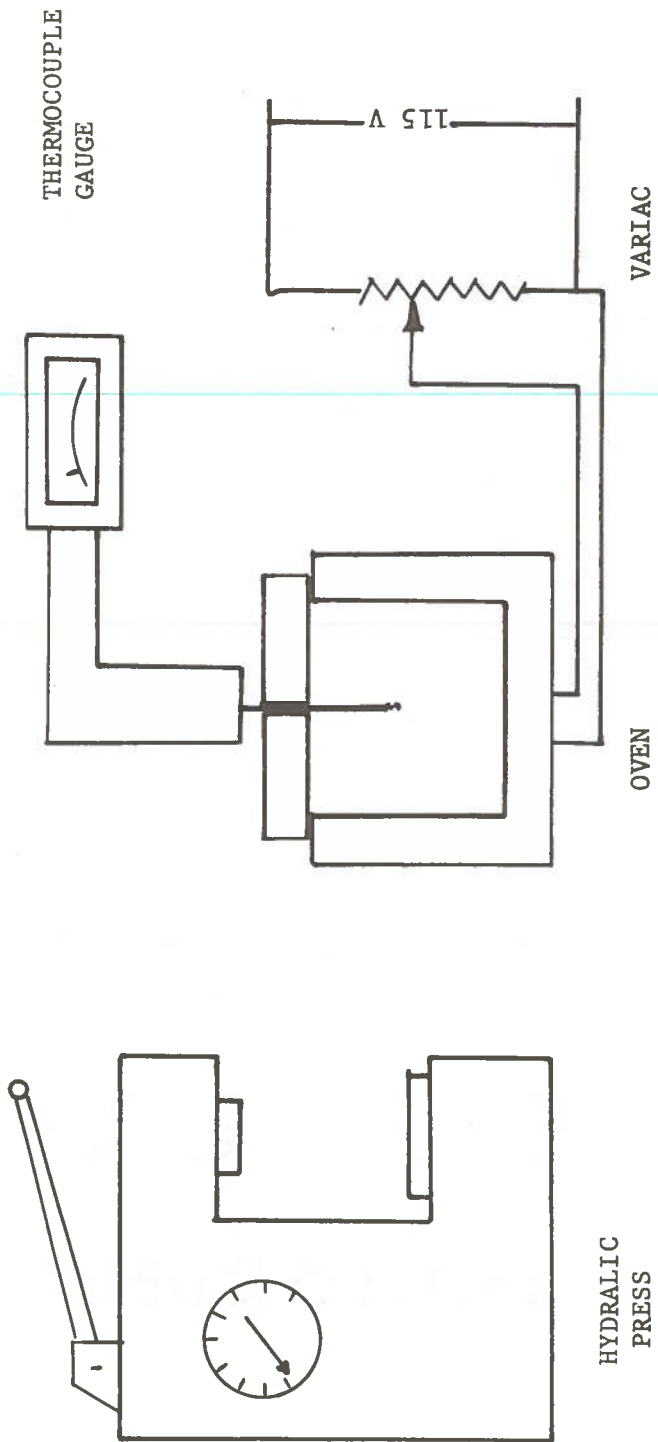

Figure 2.2

Schematic Diagram of Experimental Systems

A Research and Industrial Instruments Company C-30 hydraulic press with front mounted pressure gauge was positioned a few feet from the oven.

#### General Pressing Procedures

Initial experimentation with the equipment listed above and the die assembly resulted in the following procedure being developed for pressing the thermoluminescent dosimeter pellets:

The die body was placed in the oven and the variac adjusted to produce one of the predetermined temperatures desired [150° C, 200° C, 300° C, 400° C, and 500° C (500° C was later dropped)]. This was an overnight operation since the oven was not controlled by a thermostat and had to reach the desired temperature.

During this warm-up period, sample materials were prepared. Matheson, Coleman, and Bell reagent grade lithium fluoride and Fisher Scientific Company certified calcium fluoride were used exclusively as thermoluminescent materials. Optimum sample size for the calcium fluoride and lithium fluoride was determined to be 0.075 grams. In addition to the pure samples prepared calcium fluoride and lithium fluoride were mixed in 25%, 50%, and 75% concentrations with total sample size again being 0.075 grams. All samples were measured and wrapped in glasine sample paper.

At such a time when it was assured that the die body was at the correct temperature, it was removed from the oven using a pair of nine inch metal tongs. While holding the die body sideways the short, lower plunger was slipped into position. The die was immediately tilted onto a metal base plate. The tilting motion kept the lower plunger in place. A clean pyrex funnel was placed over the die bore and the sample poured in. The funnel was then tapped several times to insure that all of the sample went into the die. The long, upper plunger was then placed into position and rotated several times to assure a uniform powder distribution. The loaded die assembly was tilted horizontally, again using the tongs, and placed on its side in the oven. With practice the die could be loaded in 30 seconds.

Two hours later, the die assembly was removed from the oven with the tongs, tilted onto a base plate, and placed on the rim of the hydraulic press. The press was then pumped to one of three predetermined pressures. These were 1, 1 1/2, and 2 tons, which corresponded to 40,700, 61,100, and 81,400 pounds per square inch at the plunger face. From the oven to the press at correct pressure took 20 seconds. It was found through experimentation that pressures above two tons caused deformation

of the plunger in the form of bending and pitting of the polished plunger face. The pressure was maintained for five minutes and then released. The die was removed from the press and placed horizontally on a metal base plate. The pressed pellet was then removed by tapping lightly on the end of the upper plunger until it had passed completely through the die body. Occasionally, a pellet would stick to the face of one of the plungers. The only effective method found for removal of the pellet was to tap the plunger until the pellet freed itself. The die body was cleaned of any powder build-up by rotating a 1/4 inch reamer through the bore. It was then placed back into the oven to begin another cycle.

#### Irradiation Assembly

An irradiator assembly was constructed to expose the TLD pellets to a source of gamma radiation. It was constructed of methacrylate polymer. A 3/4 inch thick plexiglas plate, cut to 5 5/8 inches by 6 inches was used as the irradiator face. On the back of this plate was cemented a 5/8 inch by 7 1/4 inch support rod. A polar coordinate system was layed out on the face with major axis being at 45 degrees from each other. Three-eighth inch holes were drilled 1/4 inch deep along each axis at 1/2 inch intervals starting at the intersection. Holes were not drilled, however, on the 1/2 inch radius at the 0, 90, 180, and 270 degree positions as the holes would intersect if drilled. Each axis was labeled with an alphabetic letter,

HOLES DRILLED  $\frac{3}{8}$

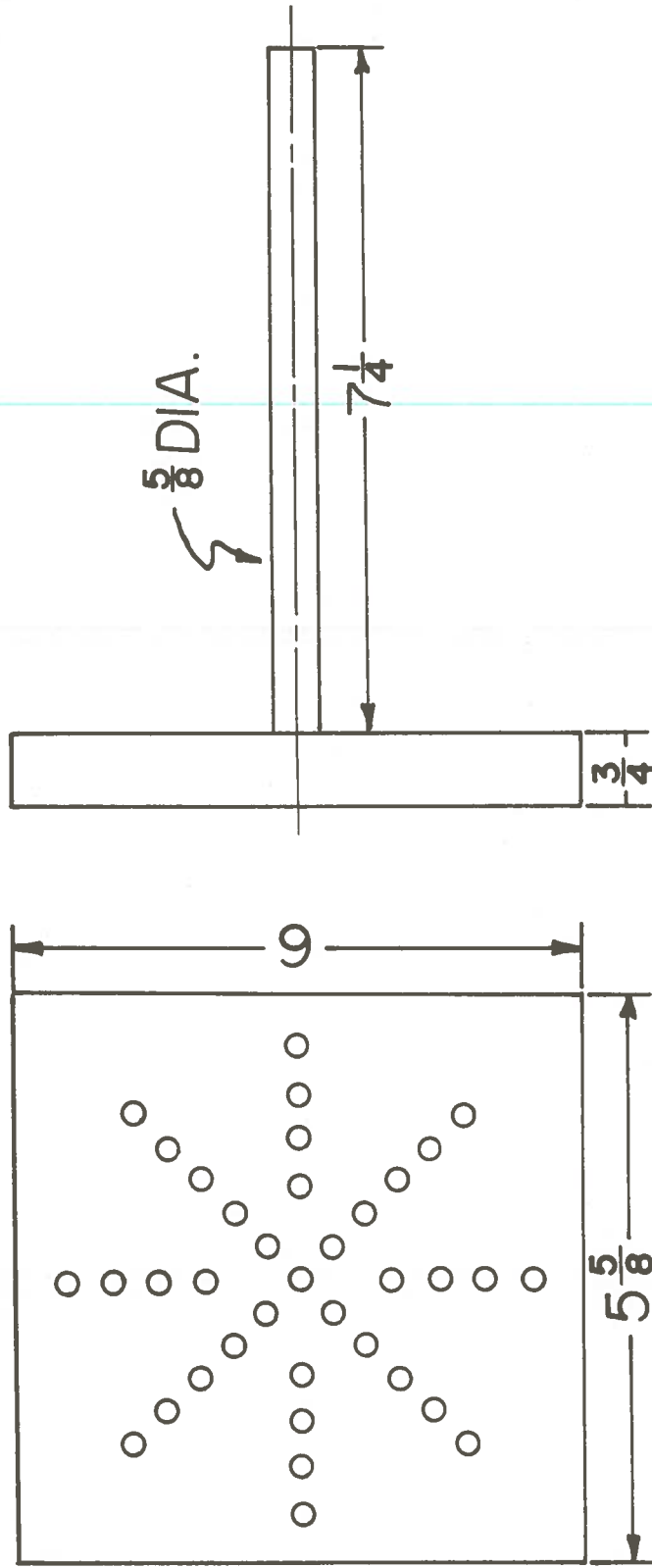

Figure 2.3

Irradiation Assembly

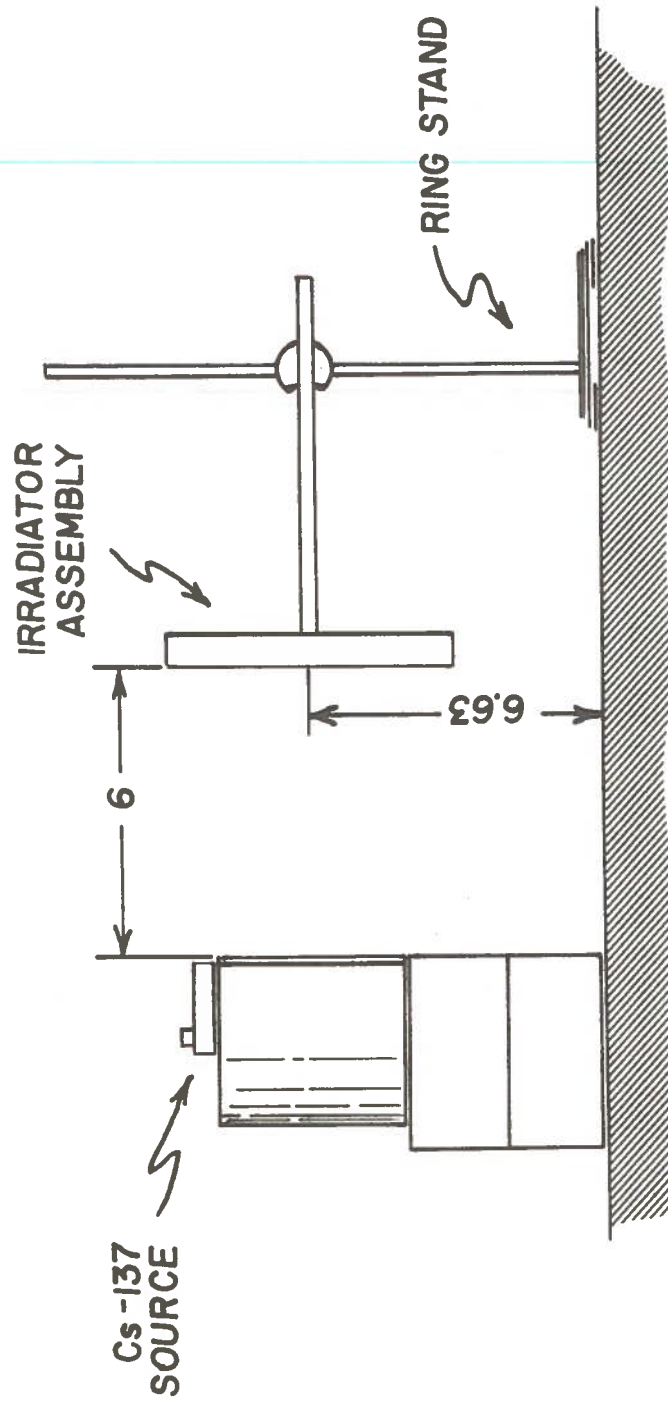

Figure 2.4  
Pellet Exposure Layout

and each radius from the center was denoted by a number. Every position could thus be identified.

When placed in the irradiator, pellets were held in place by a sheet of cardboard positioned by rubber bands.

For an actual exposure, the irradiator assembly was located six inches away from an Ohmart Corporation Triangle Flange source holder containing a 100 mCi Cs-137 source.

A draftsman's triangle was employed to assure that the face was parallel to the triangle flange face and positioned correctly for each exposure.

The radiation field, at the irradiator face, was determined through a series of exposures using fifteen Victoreen  $\text{CaF}_2:\text{Mn}$  hot pressed chips control E-1 (0.85)-7430 as dosimeters. Recommended Victoreen Corporation techniques for exposure, reading, and annealing the chips were used at all times. These TLD chips were manufactured for use with the Victoreen 2800-1, Serial Number 139, Thermoluminescent Dosimeter Reader and the Victoreen Annealing Oven Model Number 2600-62, Series #1183, which were utilized throughout this investigation.

#### Exposure and Reading Procedures

Once the field was defined, the pressed pellets were annealed and then exposed. The calcium fluoride pellets were annealed in the annealing oven for 14 hours at 400° C, the lithium fluoride pellets were processed three times through the LiF/Anneal cycle of the Victoreen TLD reader, and the lithium fluoride / calcium fluoride mixture pellets were annealed one hour at 400° C followed by 14 hours at 80° C.

The three sets of pellets were irradiated separately with each pellet



occupying the same position each time. Each set was exposed six times for one hour and one minute. This was to determine pellet sensitivity and TL peak reproducibility. Exposures of various lengths of time from one hour to 23 hours were made to check the linearity of sample response. Experiments were also performed to test pellet sensitivity to light and atmospheric effects.

Five of the 15 Victoreen chips were irradiated with each set of pellets. This provided a means of determining the relative dose to the exposed pellets.

Fifteen minutes after exposure, the Victoreen chips were read with the nitrogen purge. After these chips were read, the set of pellets were read. Fabricated pellets were read by the same procedure as that employed for the reference chips (Victoreen TLD 400), except that the nitrogen purge was not used.

In addition to the readings taken from TLD reader DVM, the TL output of each pellet was recorded on an Esterline-Angus Rectigraph DC Voltmeter. This provided a means of comparing the TL responses of each pellet.

It should be stated that the reading referred to is actually the difference between two separate readings. The first reading is the total response; the second, the background response.

## CHAPTER III

### Results

The die assembly constructed for this experiment performed as expected. The surface of the stainless steel die body was observed to oxidize after hundreds of hours at elevated temperature, but did not contaminate the TLD samples being pressed. The polished chromium plated plungers lasted 10 to 15 times longer than the unplated plungers when used at 400° C or less.

The pellets produced appeared to be the same color as the original powder when pressure and temperature were moderate. As temperature and pressure were increased, however, the color gradually changed to a light brown, and the pellets became translucent. This change occurred at 500° C and one ton using calcium fluoride, and 300° C and 1.5 tons using lithium fluoride. With this color change came a dramatic decrease in sensitivity. Once this behavior had been observed and verified for calcium fluoride, pellets which exhibited the color change were discarded.

Data obtained for all pellet exposures are presented in Figures 3.1 through 3.30. Each is a plot of TLD pellet digital readout versus the relative dose, where the relative dose was determined by reading commercial calcium fluoride chips exposed at the same time as the pressed pellets.

Handling methods were found to play a significant role in TL output reproducibility. All pellets produced from the reagent grade lithium fluoride and calcium fluoride displayed elevated light emission when read following rough handling. In order to get the best results, pellets had

to be annealed and handled carefully. A subsequent investigation revealed that by using a vacuum pickup mechanism to transport the pellet this triboluminescent effect could be reduced substantially.

The data obtained are discussed and interpreted in the following chapter.

---

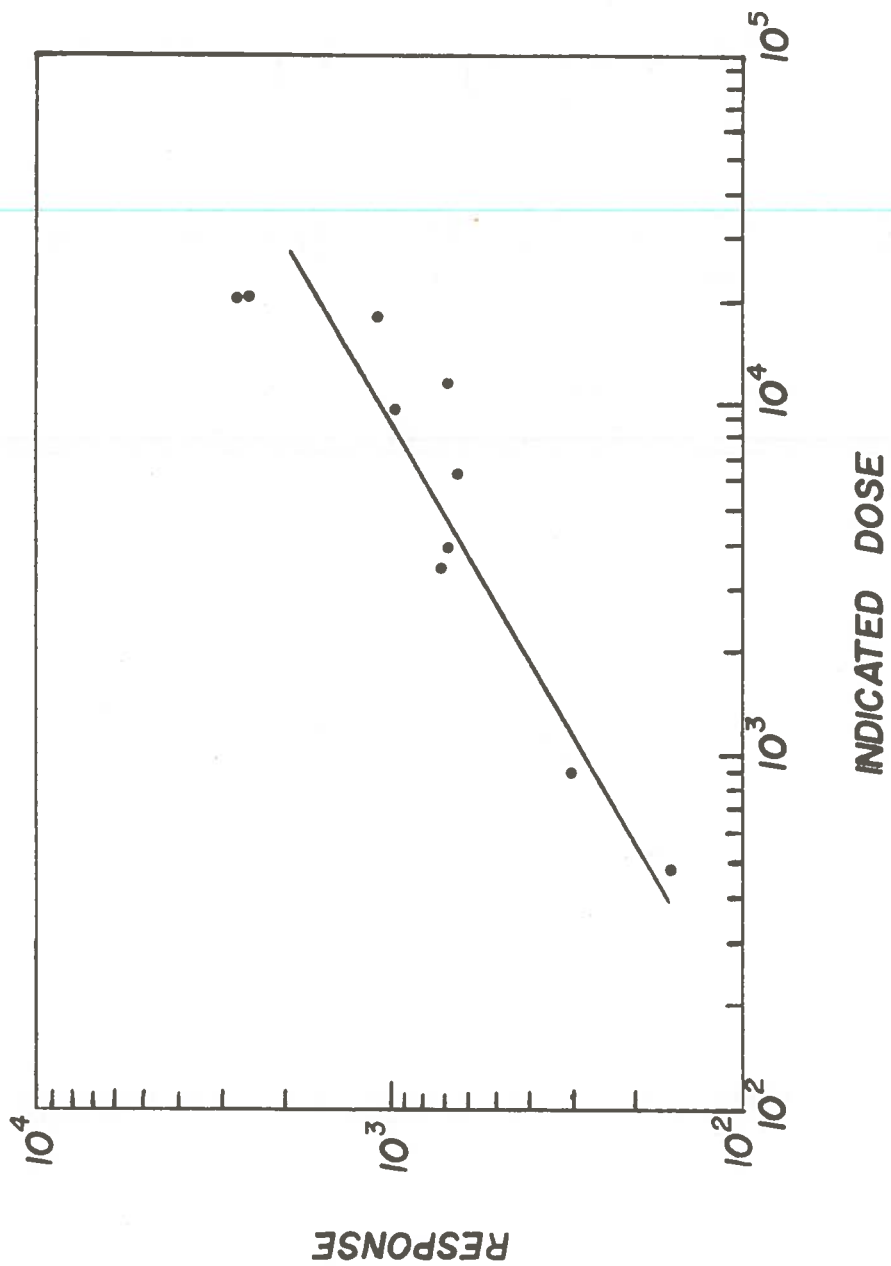

Figure 3.1  
Plot of Response versus Indicated Dose  
for  $\text{CaF}_2$  at  $150^\circ \text{C}$  and 1.0 ton

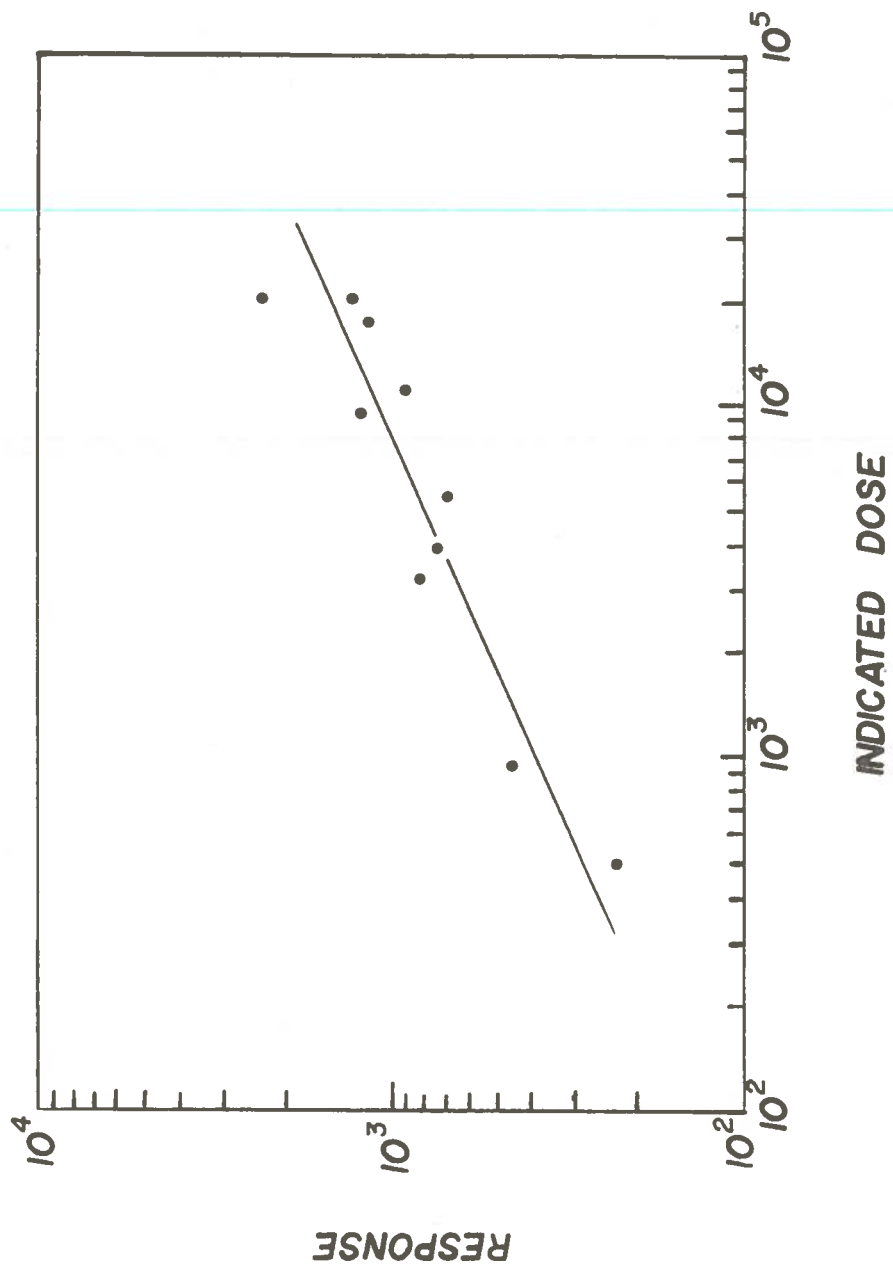

Figure 3.2  
Plot of Response versus Indicated Dose  
for  $\text{CaF}_2$  at  $150^\circ\text{C}$  and 1.5 tons

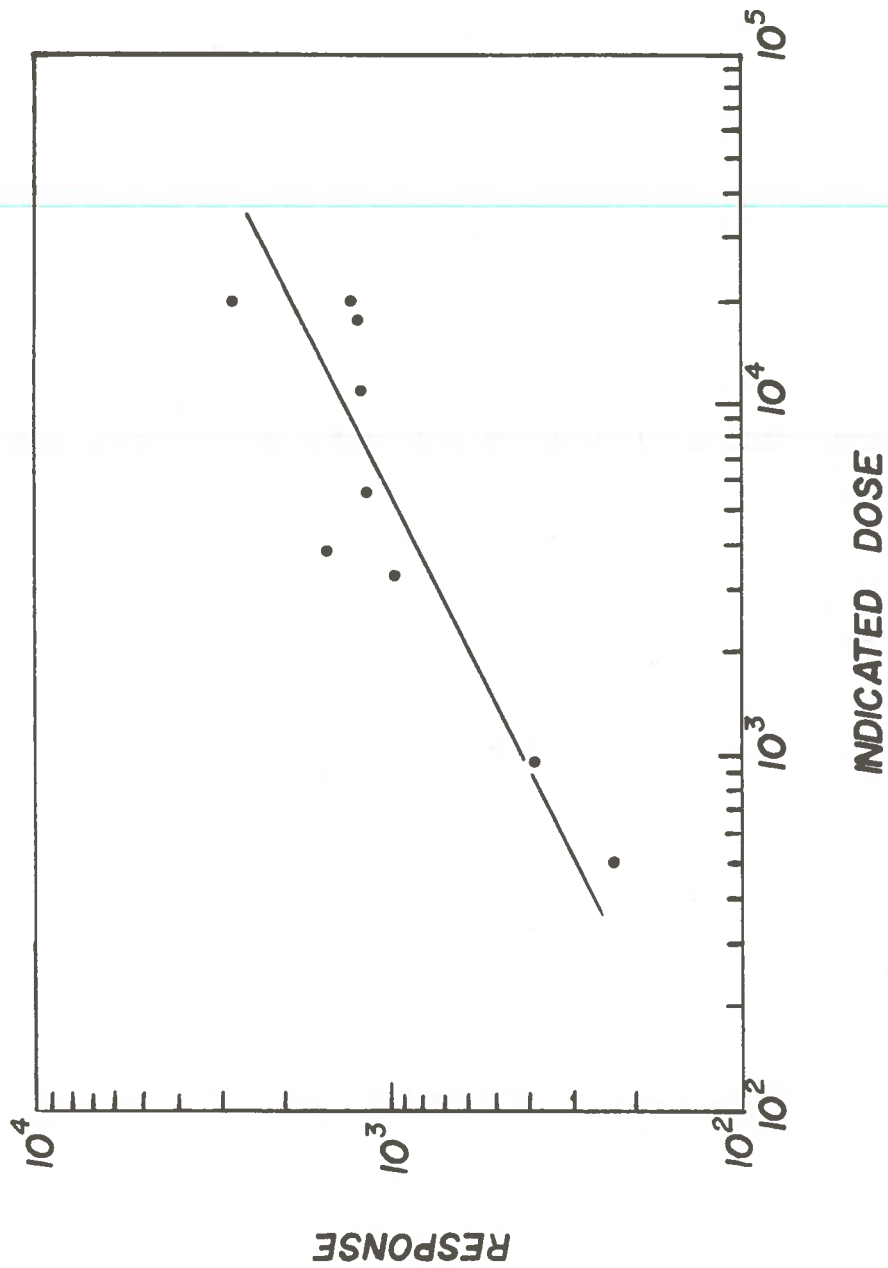

Figure 3.3

Plot of Response versus Indicated Dose  
for  $\text{CaF}_2$  at  $150^\circ\text{C}$  and 2.0 tons

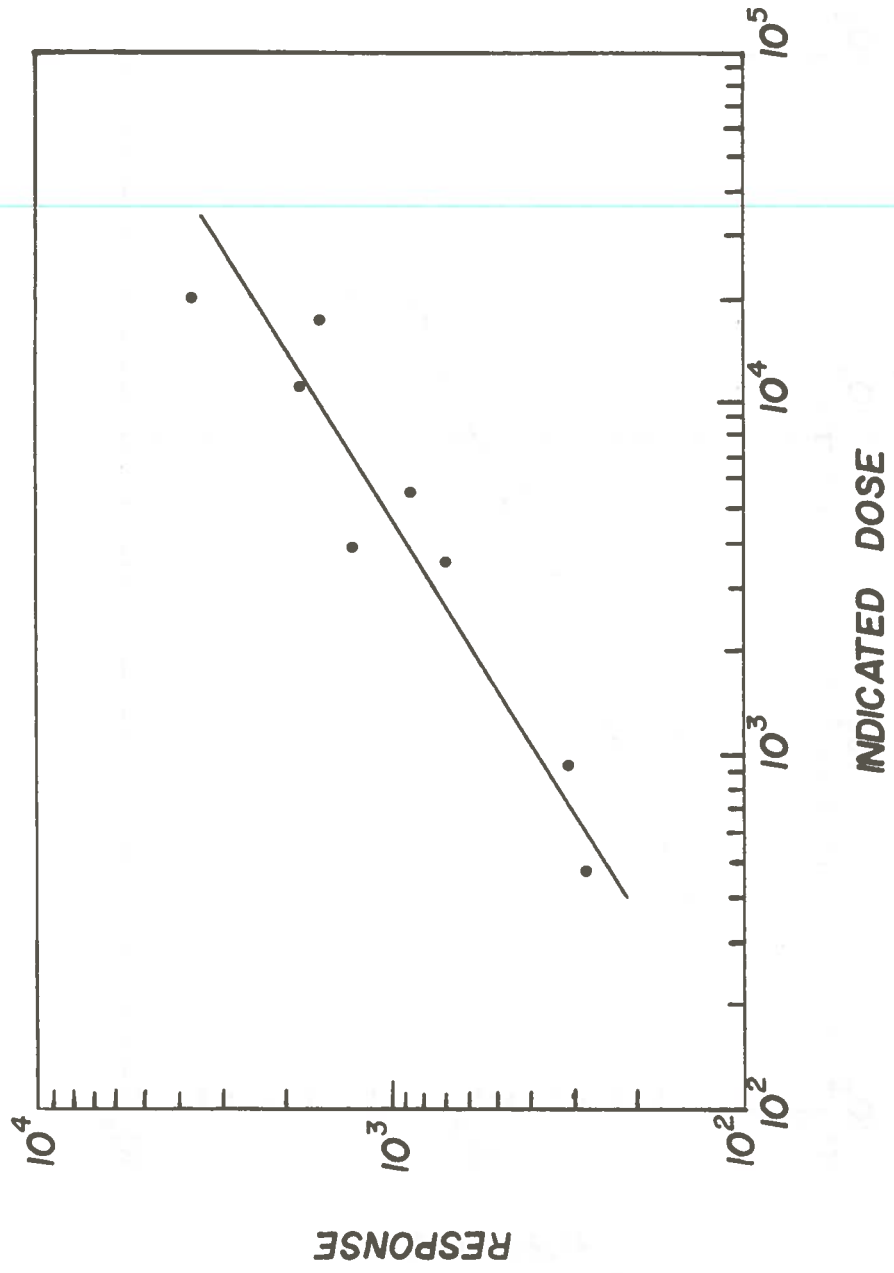

Figure 3.4  
Plot of Response versus Indicated Dose  
for CaF<sub>2</sub> at 200° C and 1.0 ton

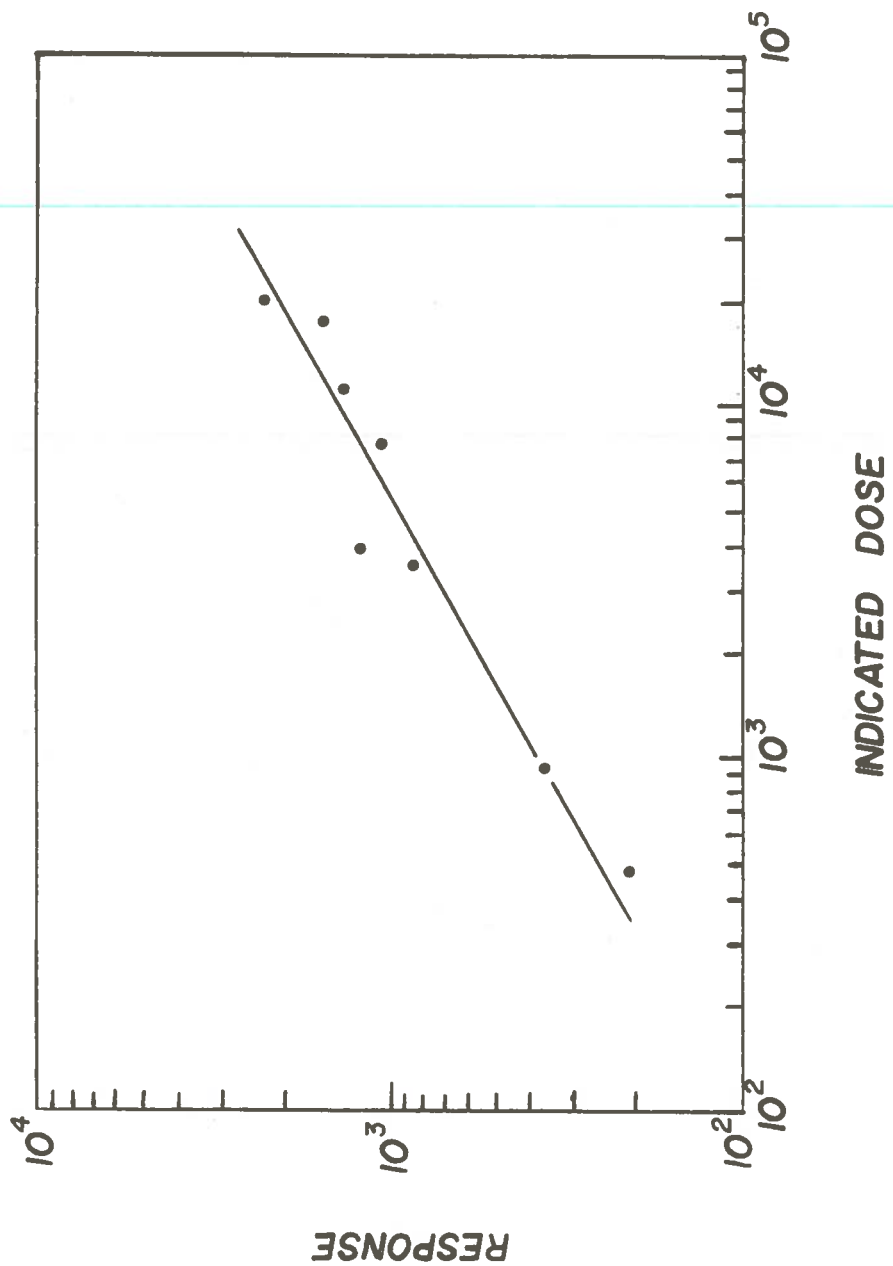

Figure 3.6  
Plot of Response versus Indicated Dose  
for  $\text{CaF}_2$  at  $200^\circ\text{C}$  and 2.0 tons



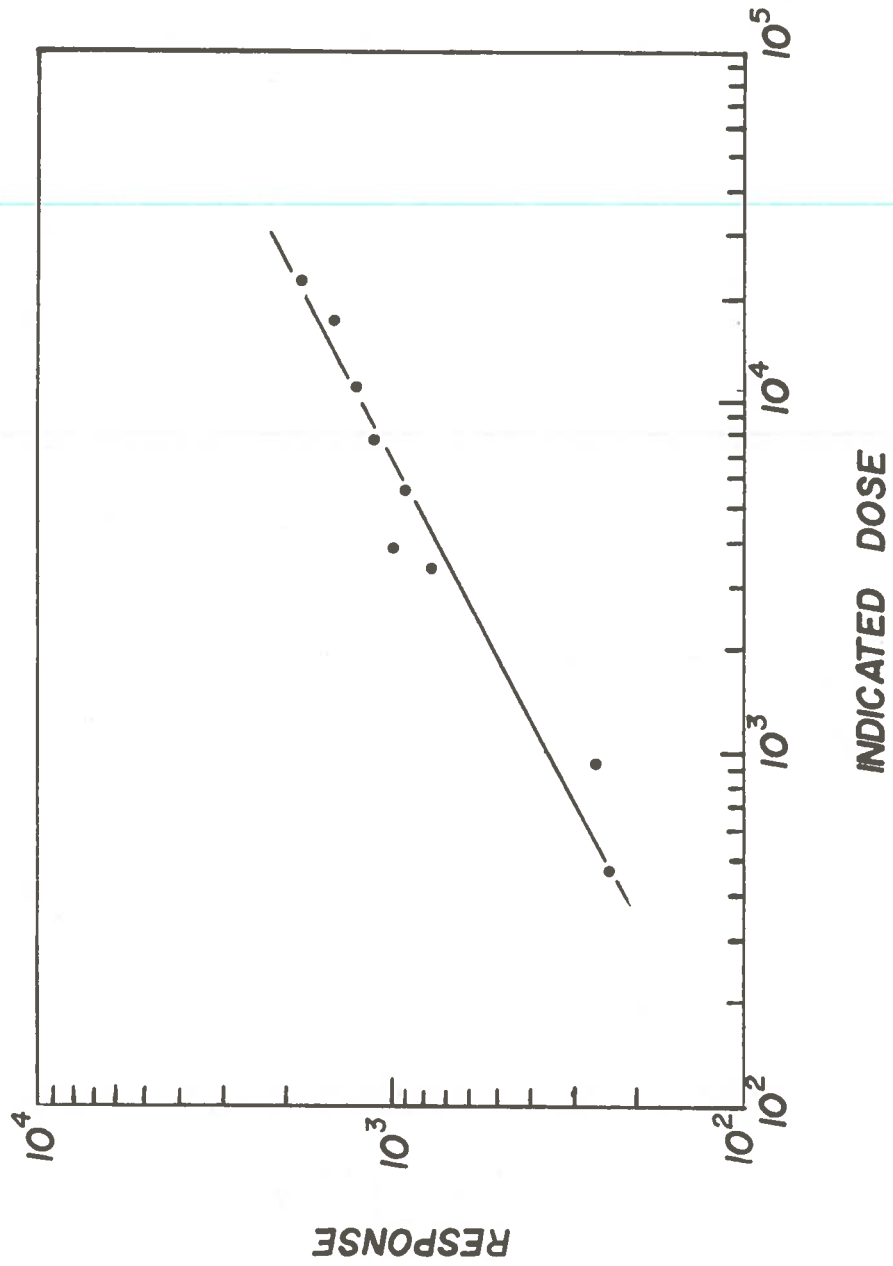

Figure 3.7  
Plot of Response versus Indicated Dose  
for  $\text{CaF}_2$  at  $300^\circ\text{C}$  and 1.0 ton

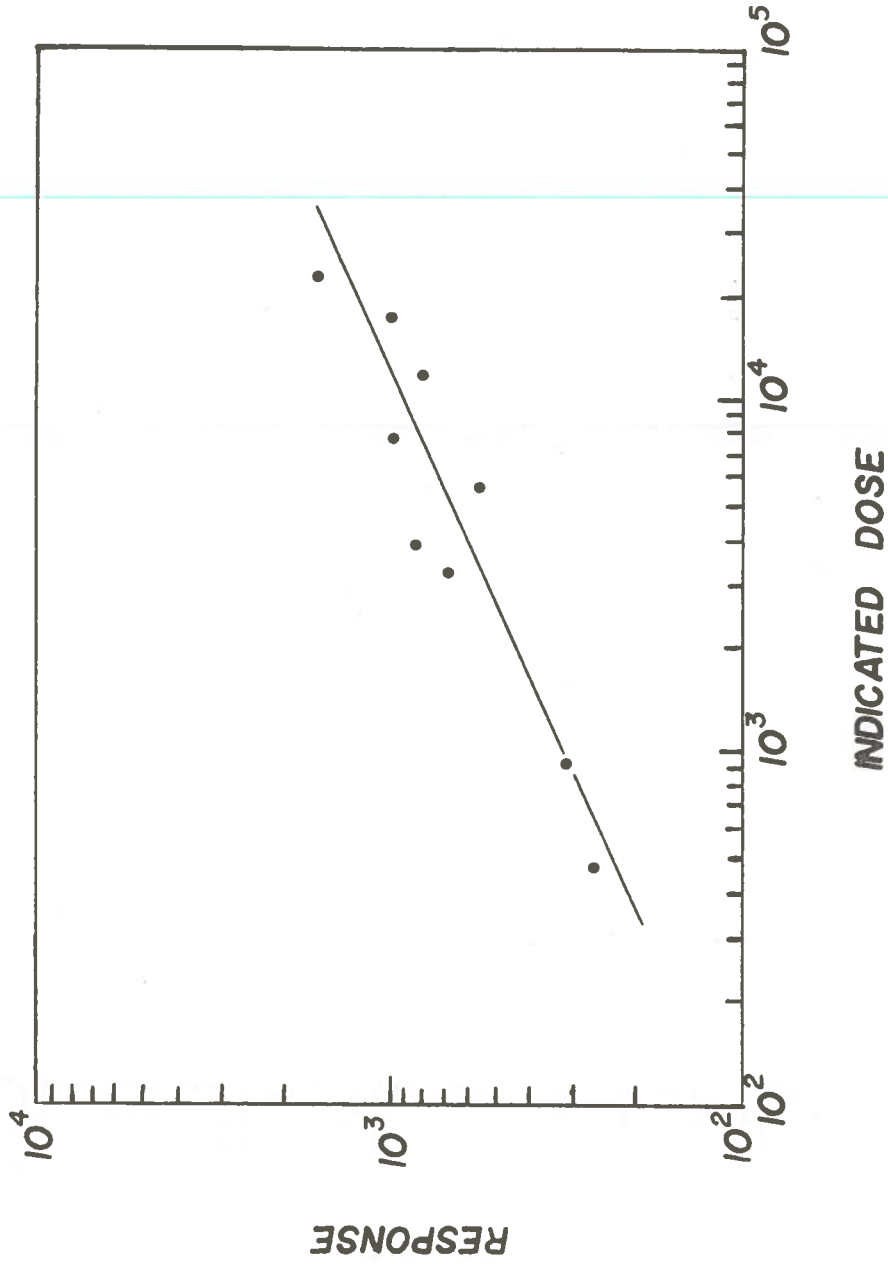

Figure 3.8  
Plot of Response versus Indicated Dose  
for  $\text{CaF}_2$  at  $300^\circ\text{C}$  and 1.5 tons

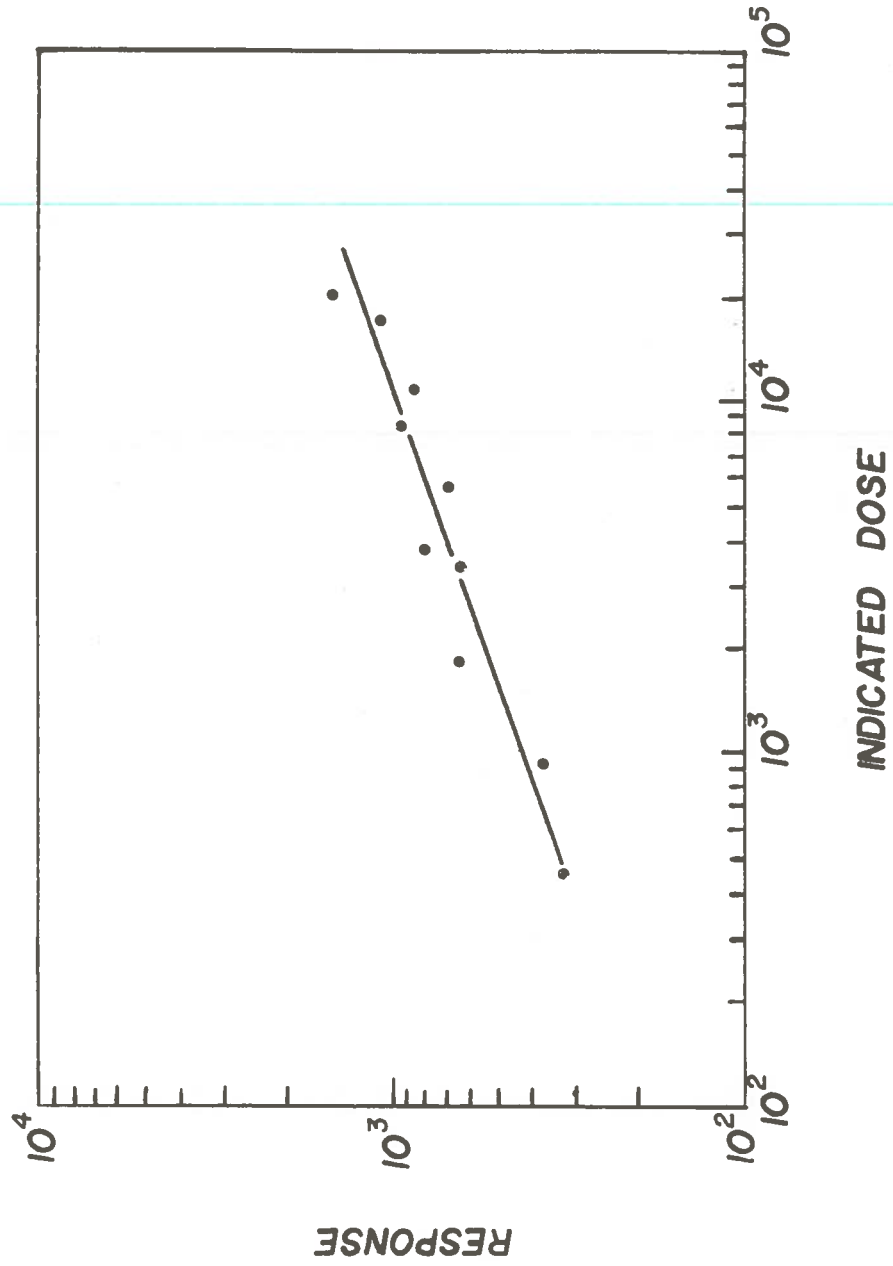
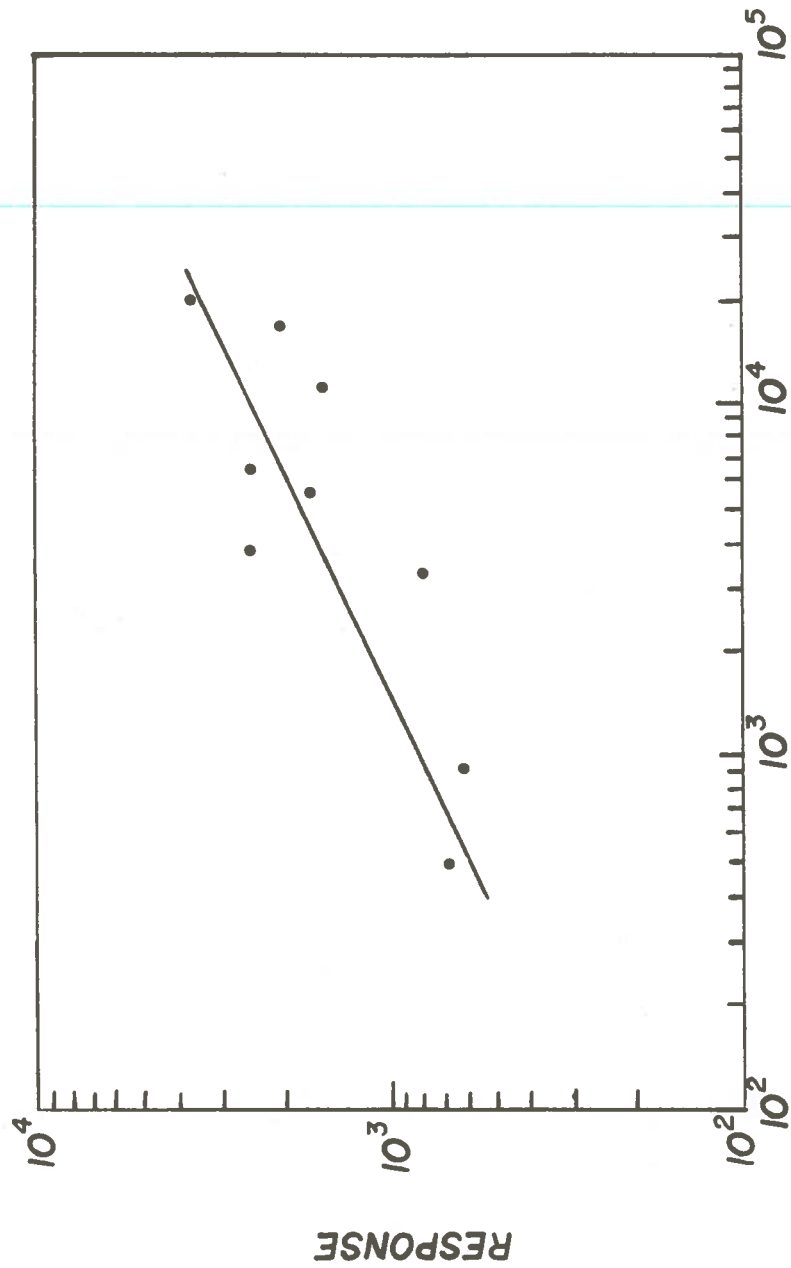

Figure 3.9  
Plot of Response versus Indicated Dose  
for  $\text{CaF}_2$  at  $300^\circ\text{C}$  and 2.0 tons



INDICATED DOSE

Figure 3.10

Plot of Response versus Indicated Dose  
for  $\text{CaF}_2$  at  $400^\circ\text{C}$  and 1.0 ton

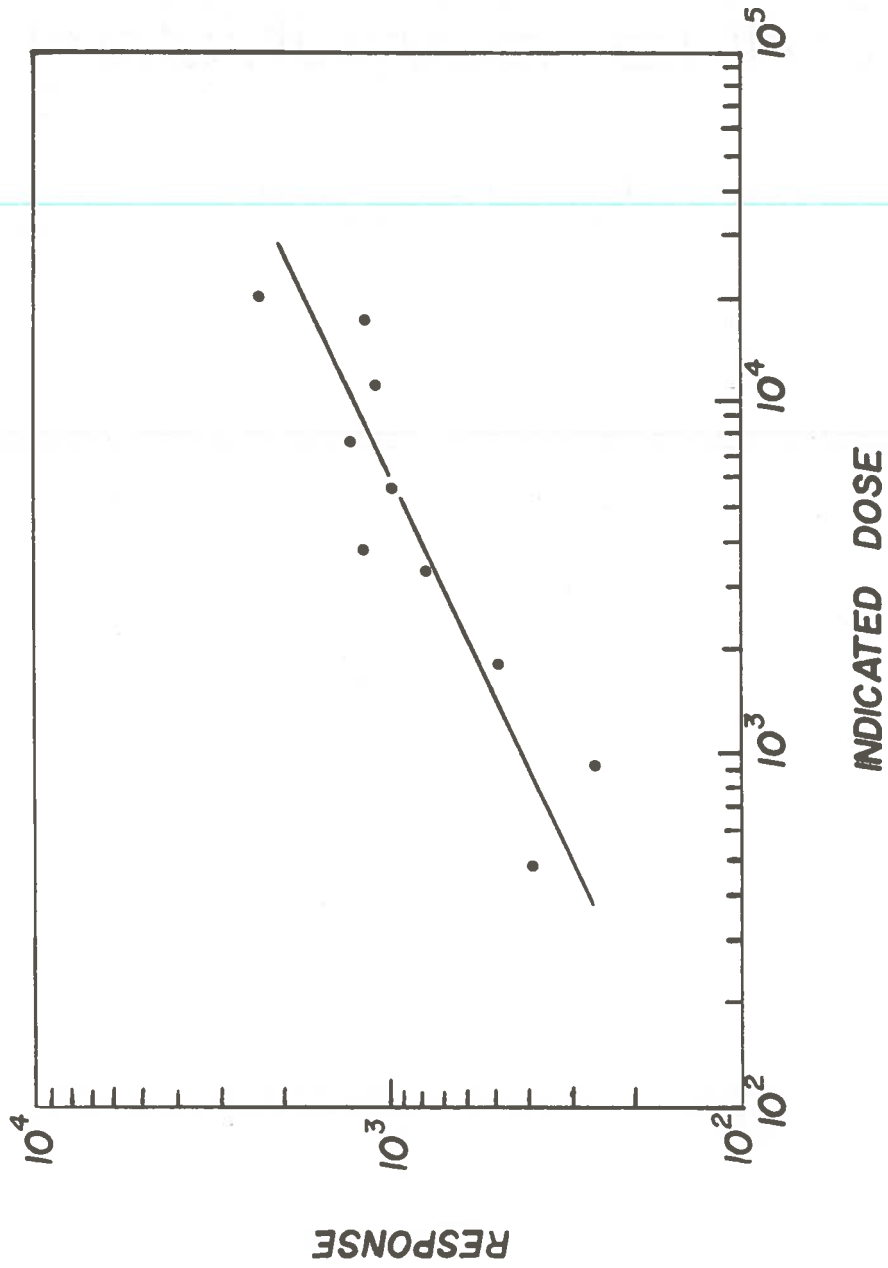

Figure 3.11

Plot of Response versus Indicated Dose for  $\text{CaF}_2$  at  $400^\circ\text{C}$  and 1.5 tons

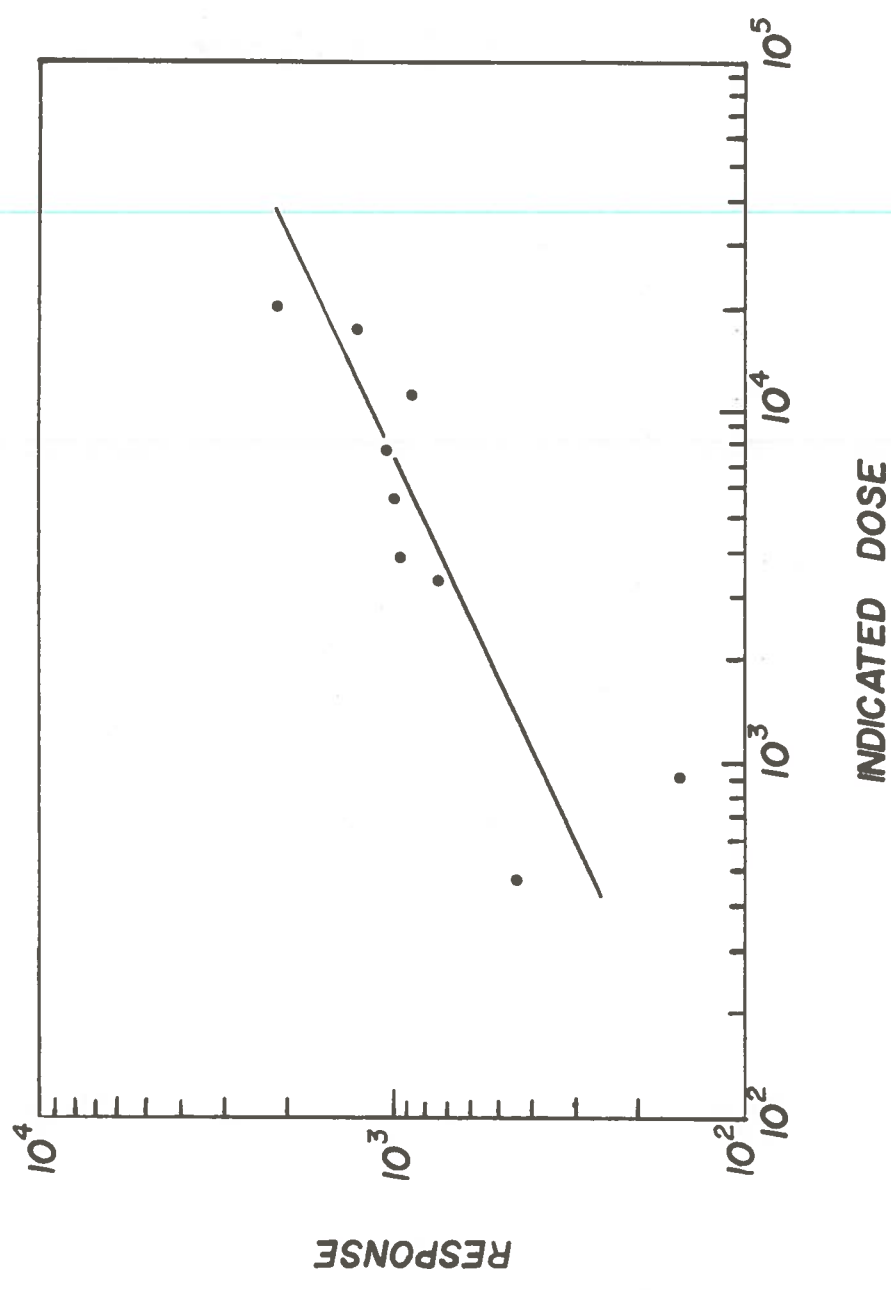

Figure 3.12  
Plot of Response versus Indicated Dose  
for  $\text{CaF}_2$  at  $400^\circ\text{C}$  and 2.0 tons

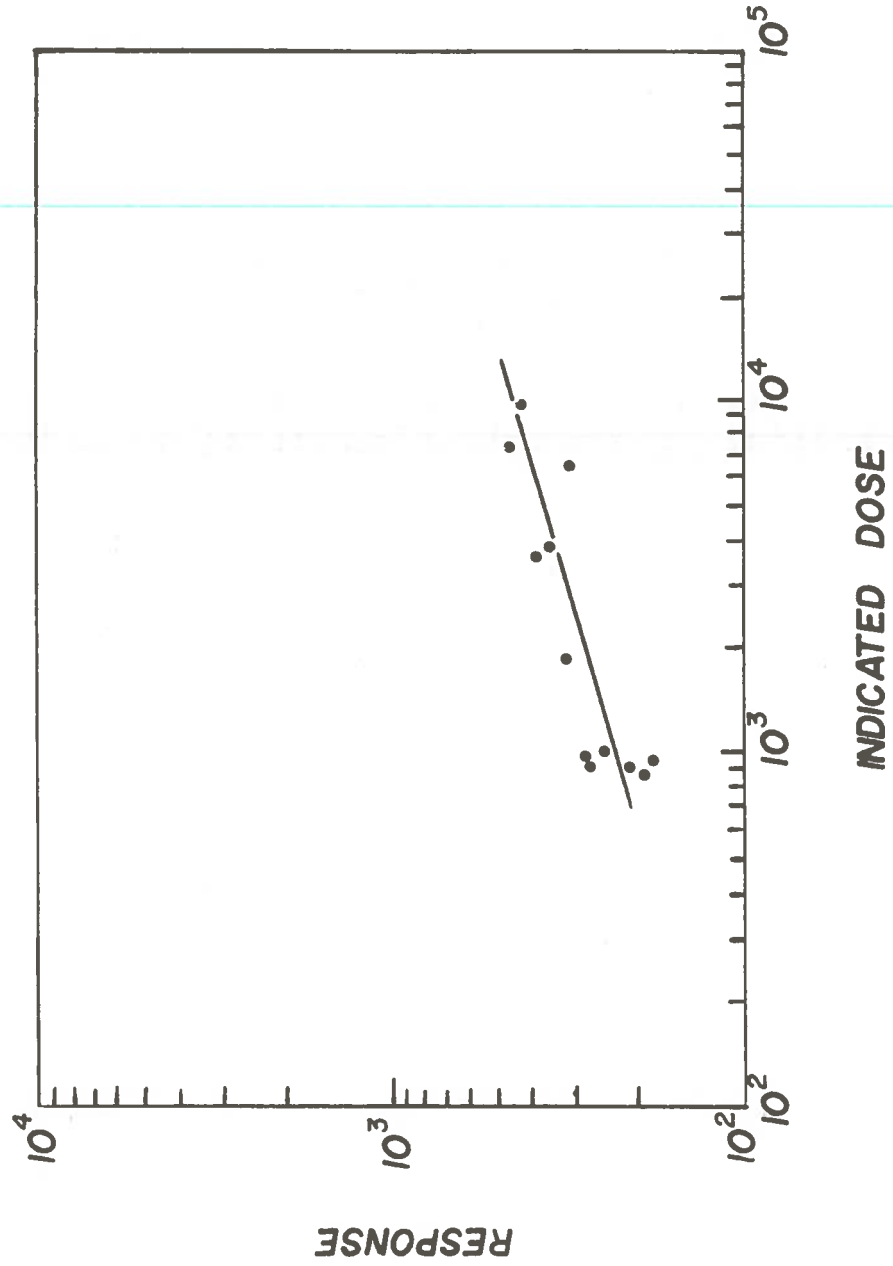

Figure 3.13

Plot of Response versus Indicated Dose  
for LiF at 150° C and 1.0 ton

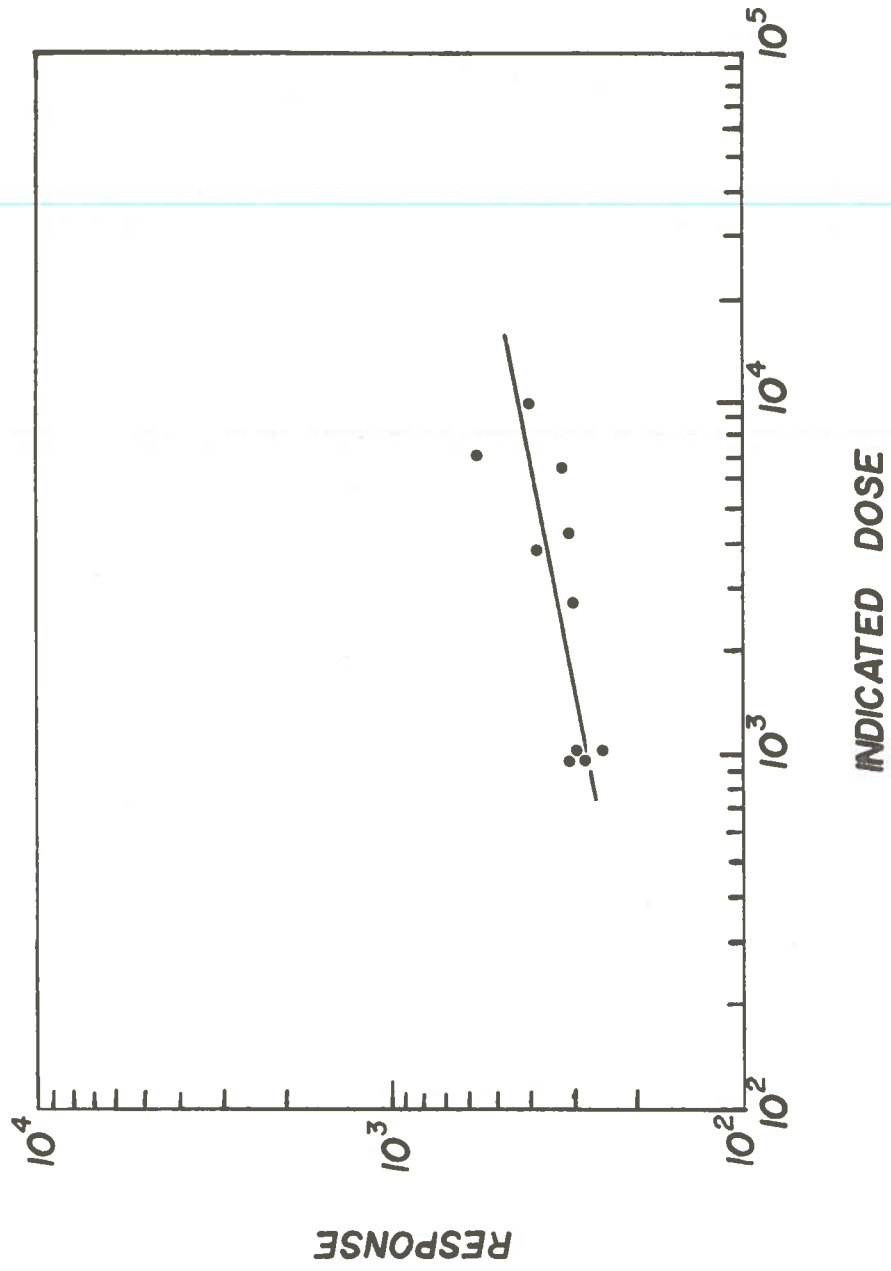

Figure 3.14  
Plot of Response versus Indicated Dose  
for LiF at 150° C and 1.5 tons



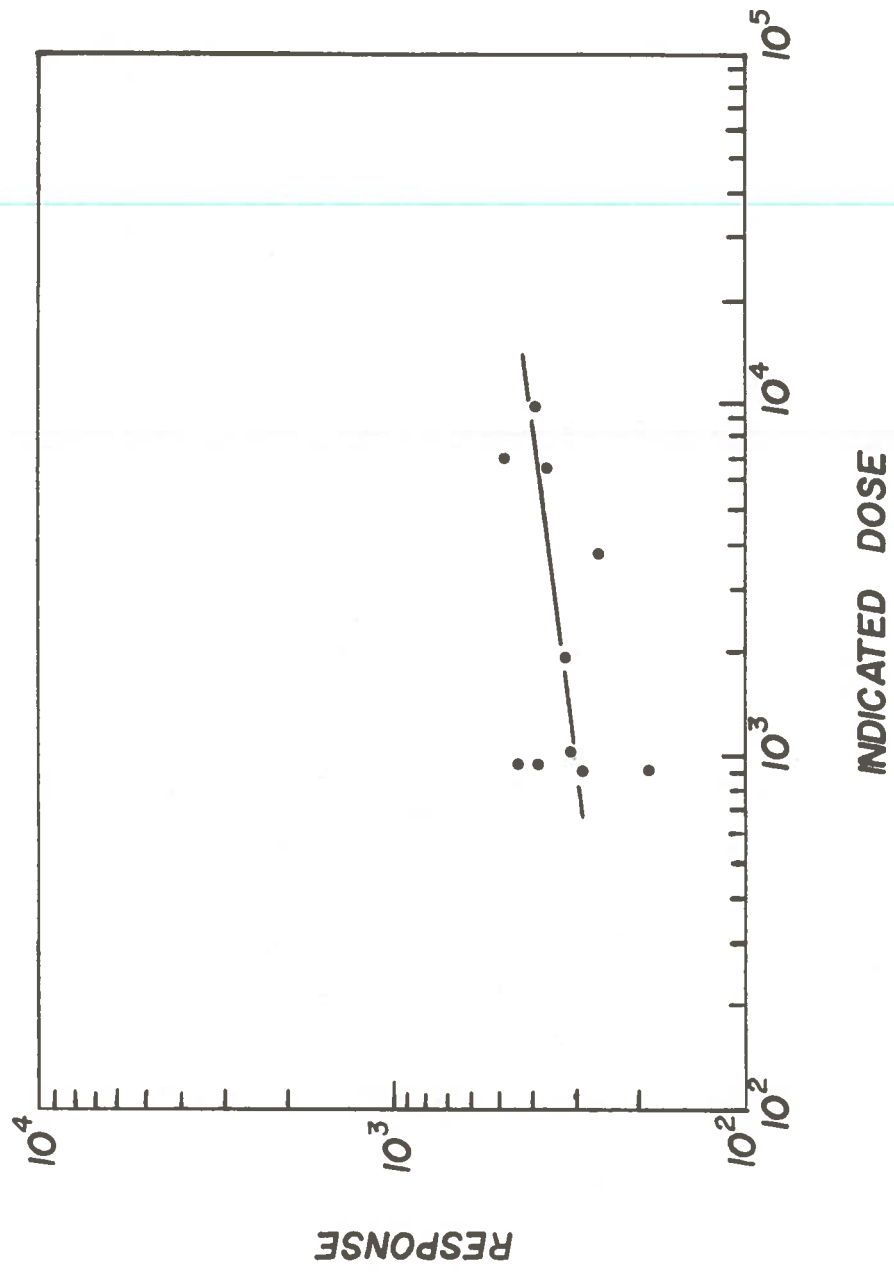

Figure 3.15  
Plot of Response versus Indicated Dose  
for LiF at 150° C and 2.0 tons

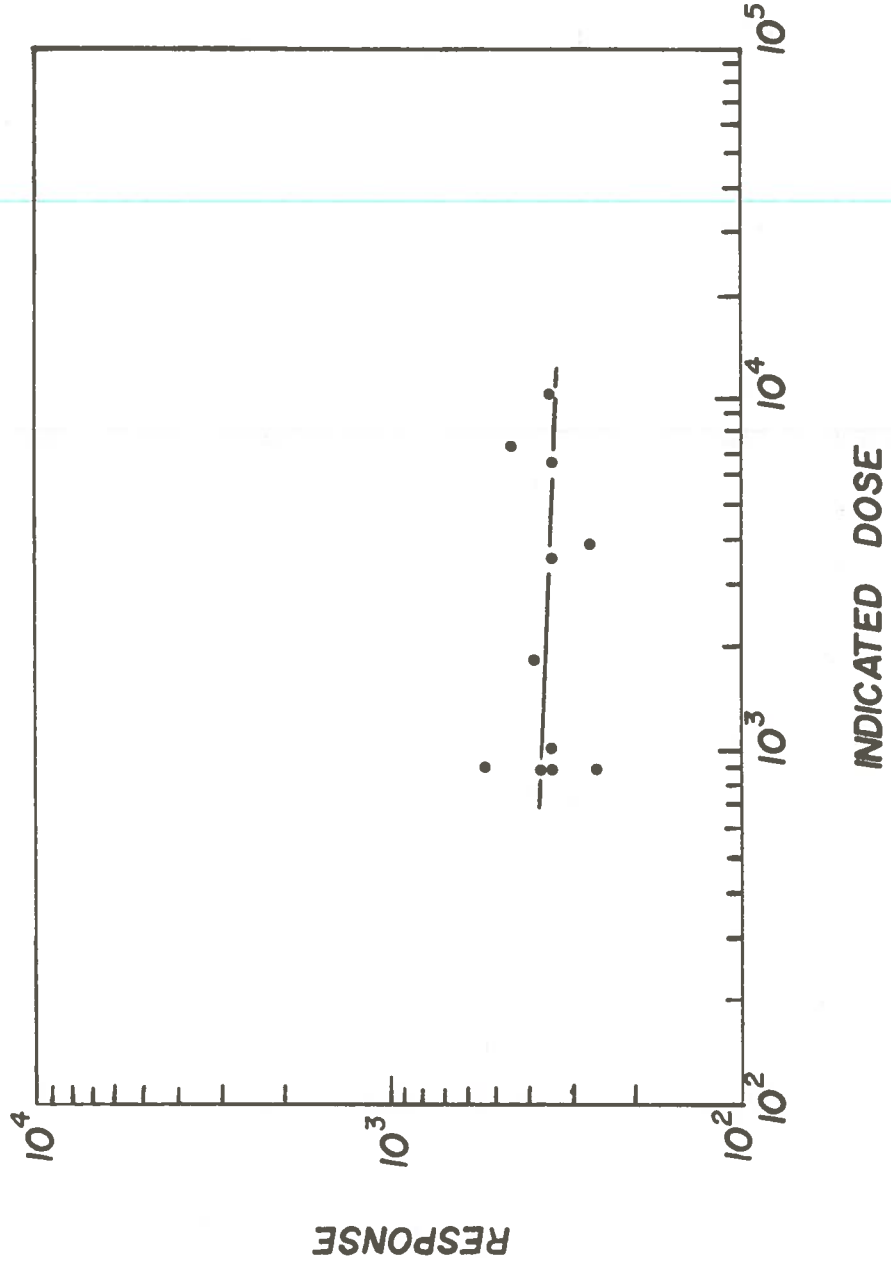

Figure 3.16  
Plot of Response versus Indicated Dose  
for LiF at 200° C and 1.0 ton

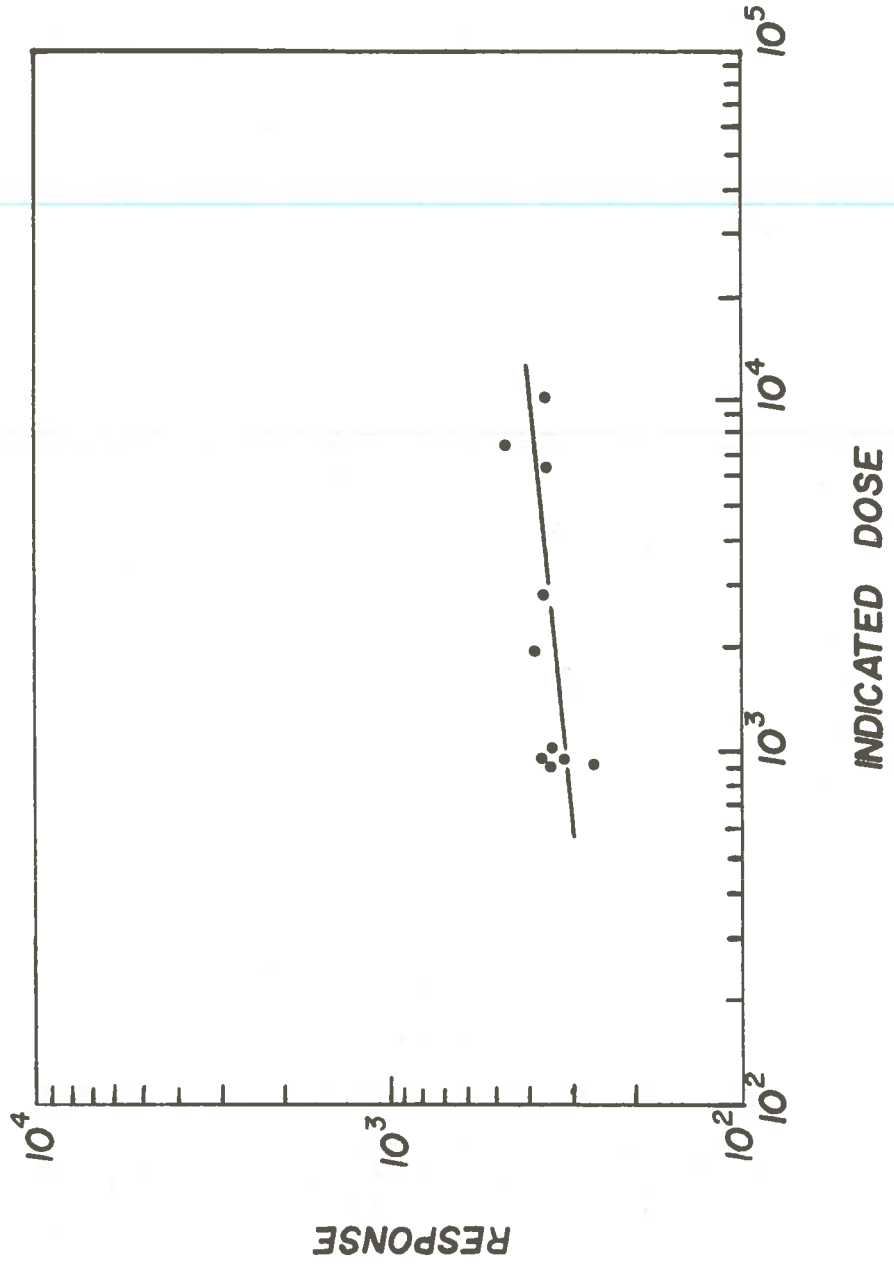

Figure 3.17  
Plot of Response versus Indicated Dose  
for LiF at 200° C and 1.5 tons

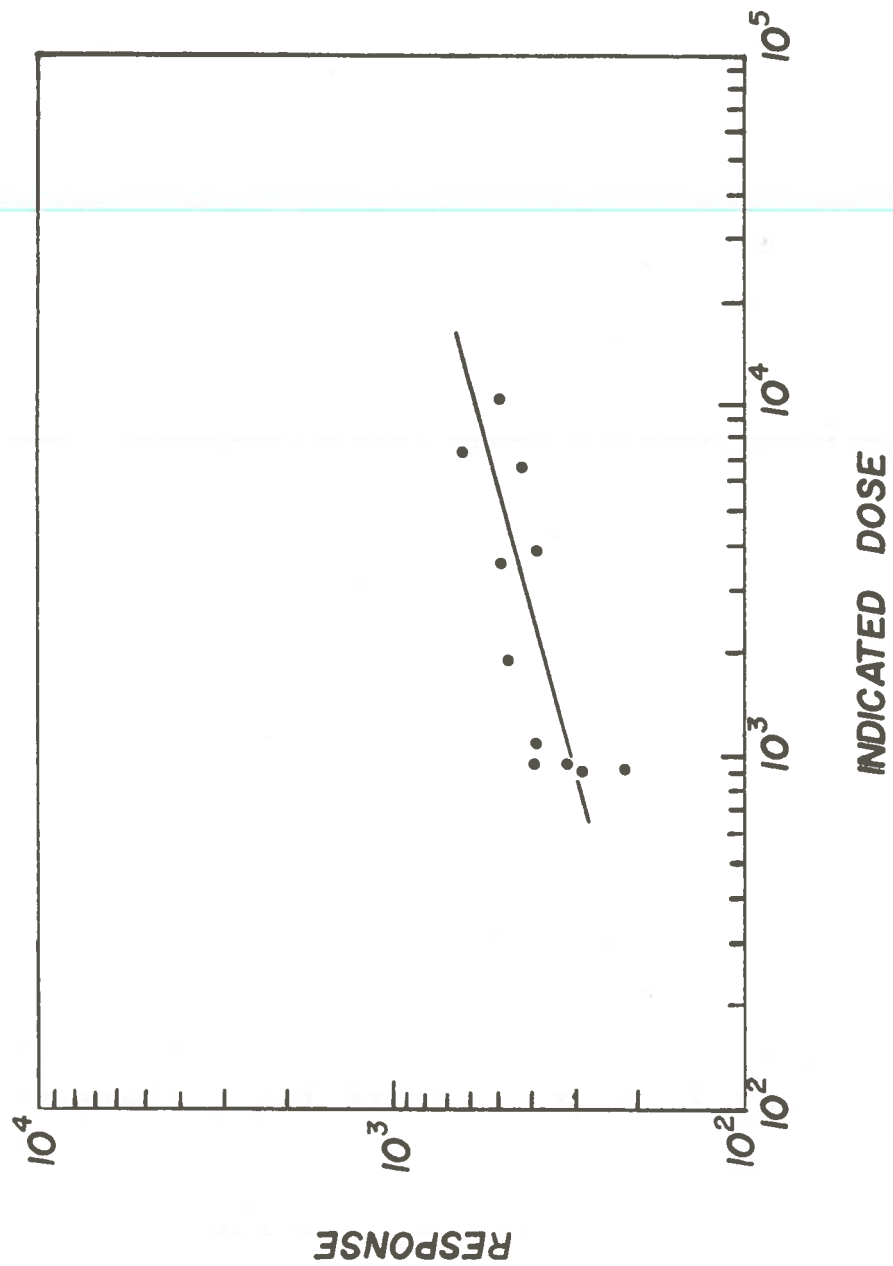

Figure 3.18  
Plot of Response versus Indicated Dose  
for LiF at 200° C and 2.0 tons

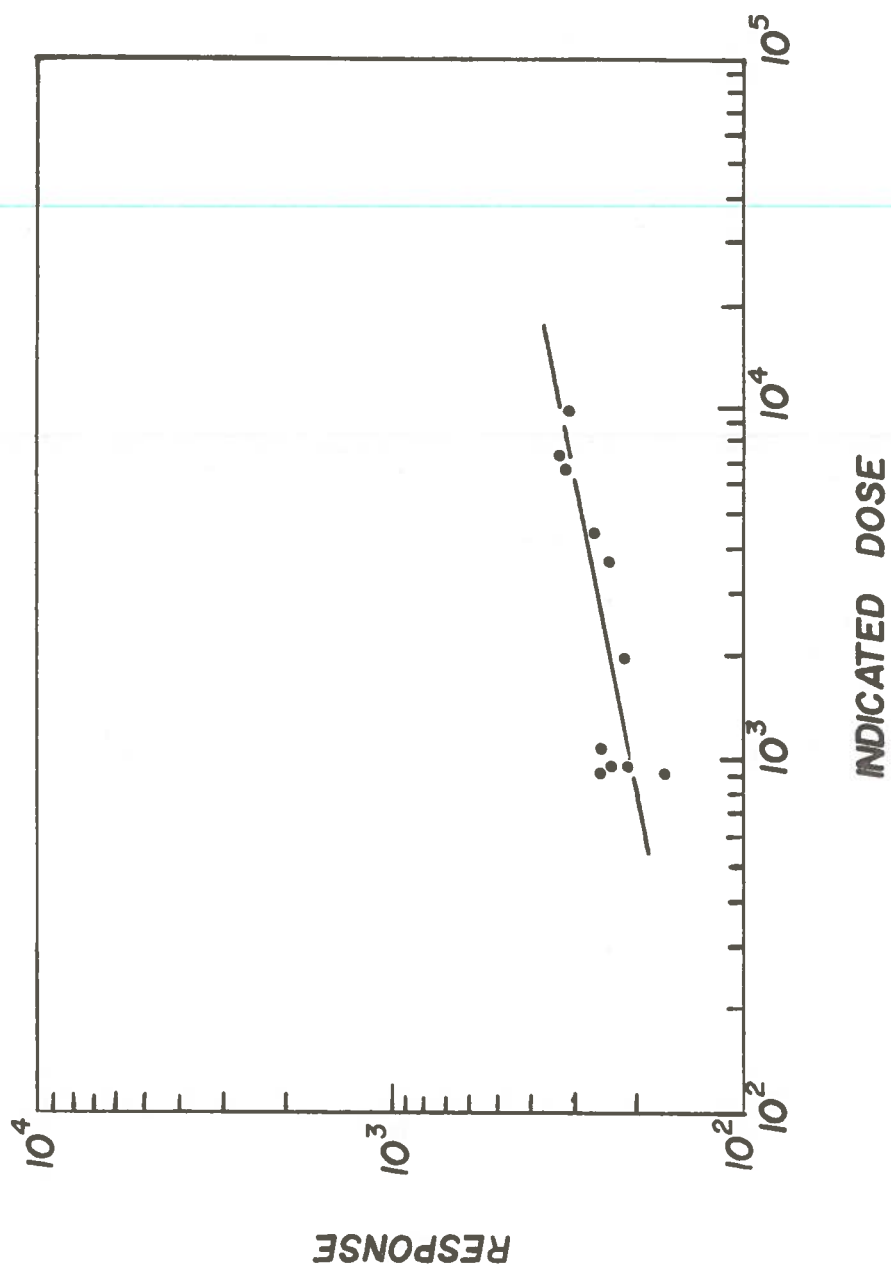

Figure 3.19

Plot of Response versus Indicated Dose  
for LiF at 300° C and 1.0 ton

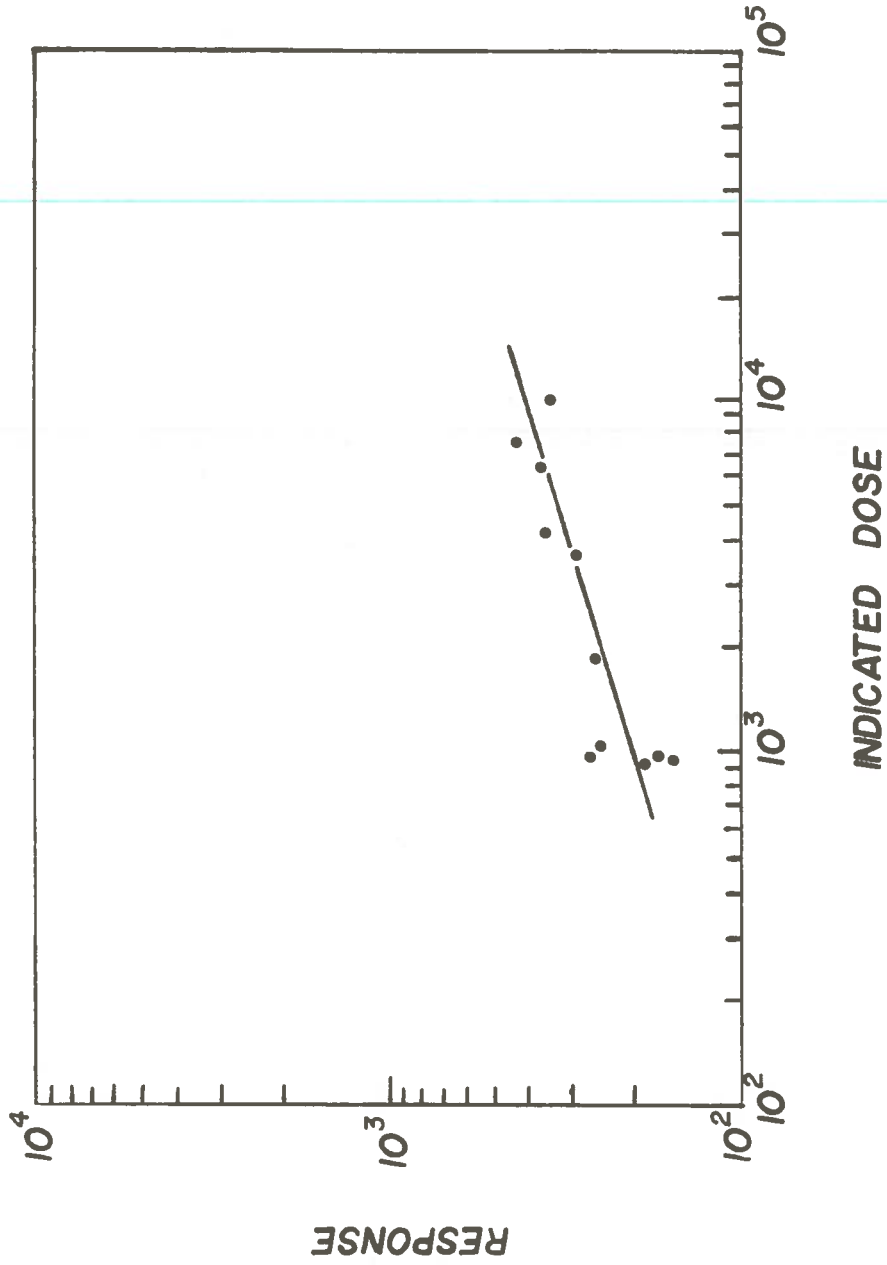

Figure 3.20  
Plot of Response versus Indicated Dose  
for LiF at 300° C and 1.5 tons

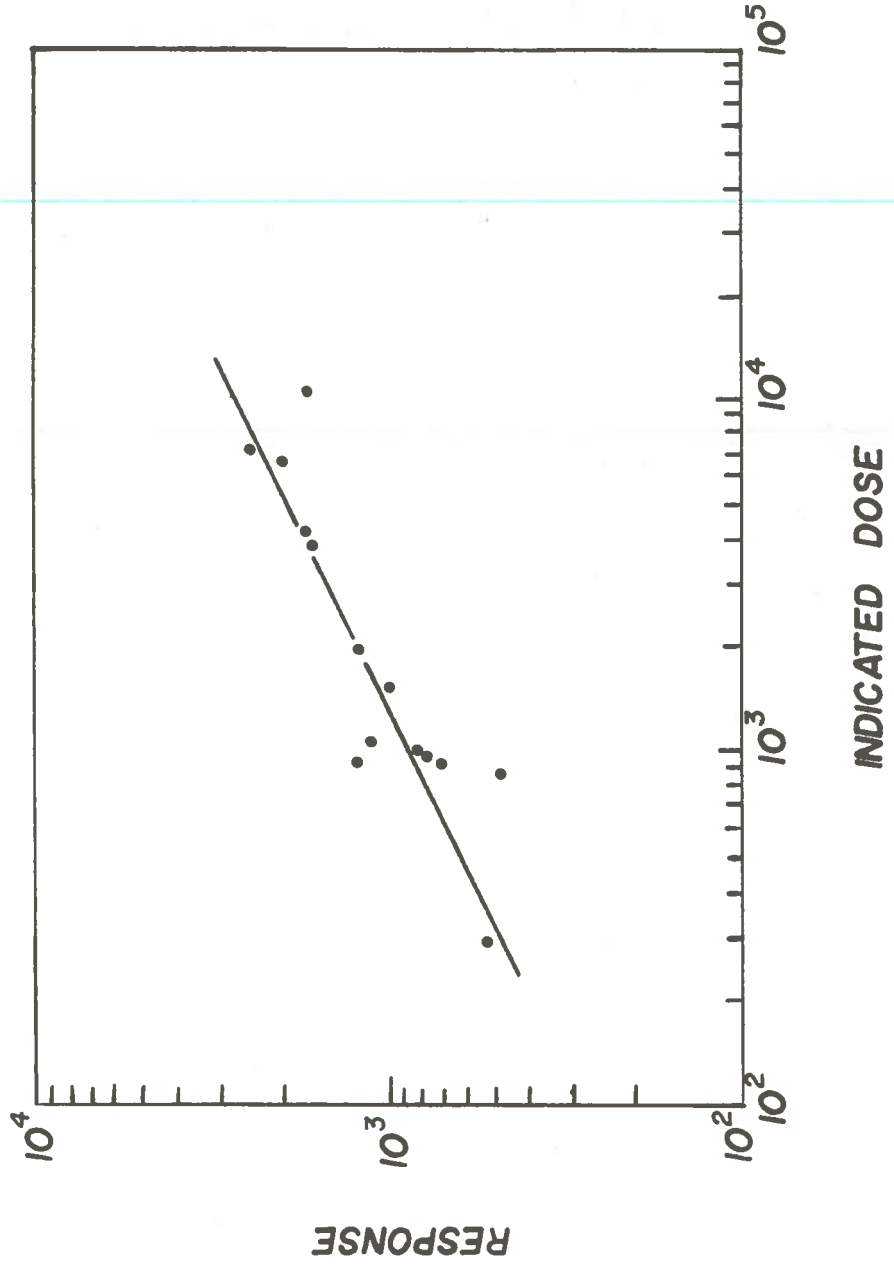

Figure 3.21  
Plot of Response versus Indicated Dose  
for LiF at 300° C and 2.0 tons

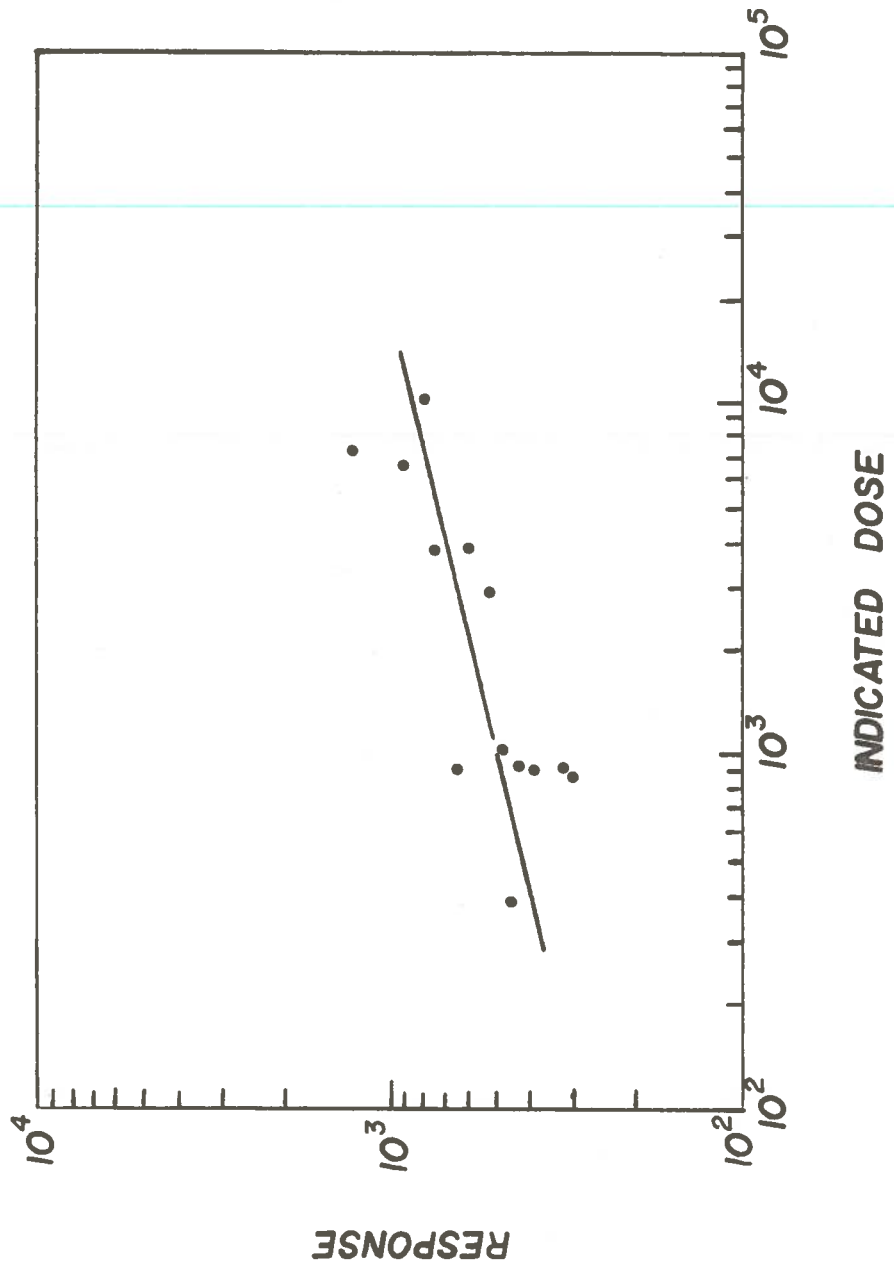
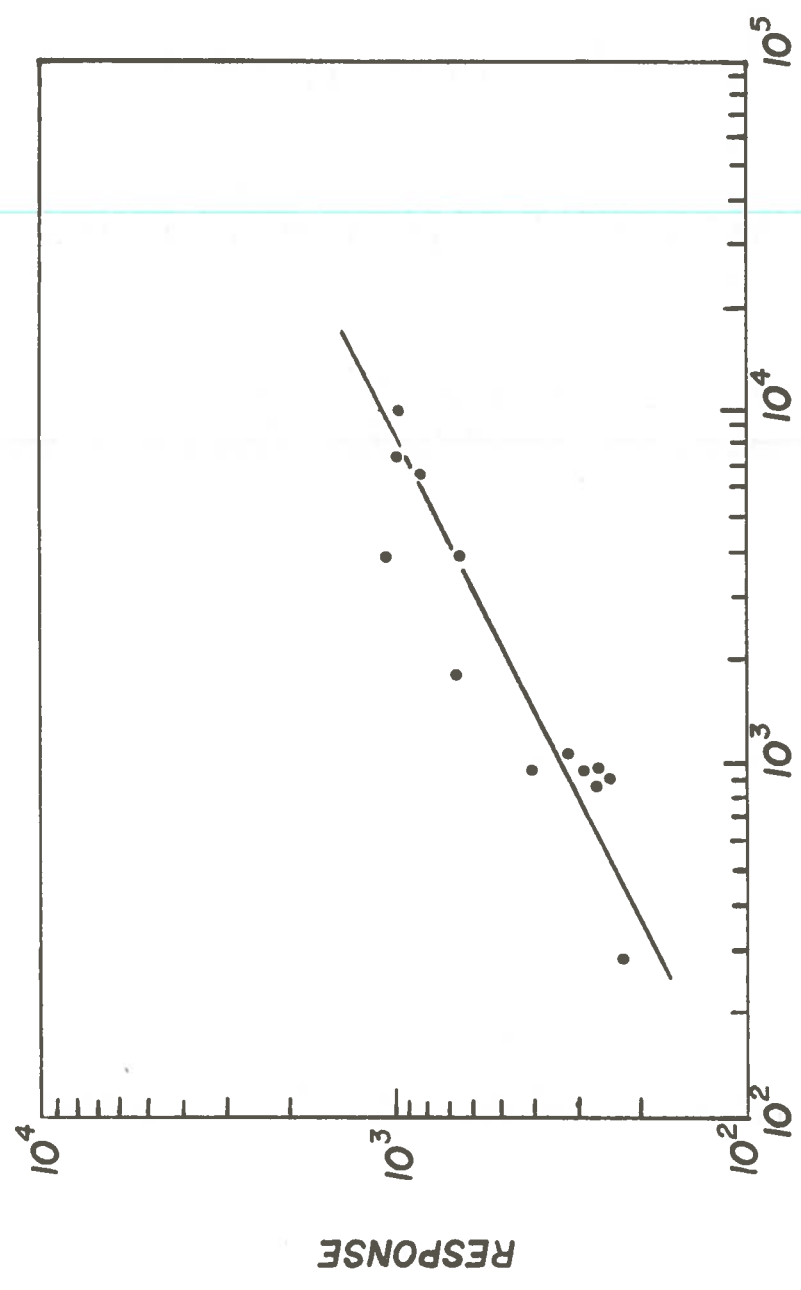

Figure 3.22  
Plot of Response versus Indicated Dose  
for LiF at 400° C and 1.0 ton





INDICATED DOSE

Figure 3.23  
Plot of Response versus Indicated Dose  
for LiF at 400° C and 1.5 tons

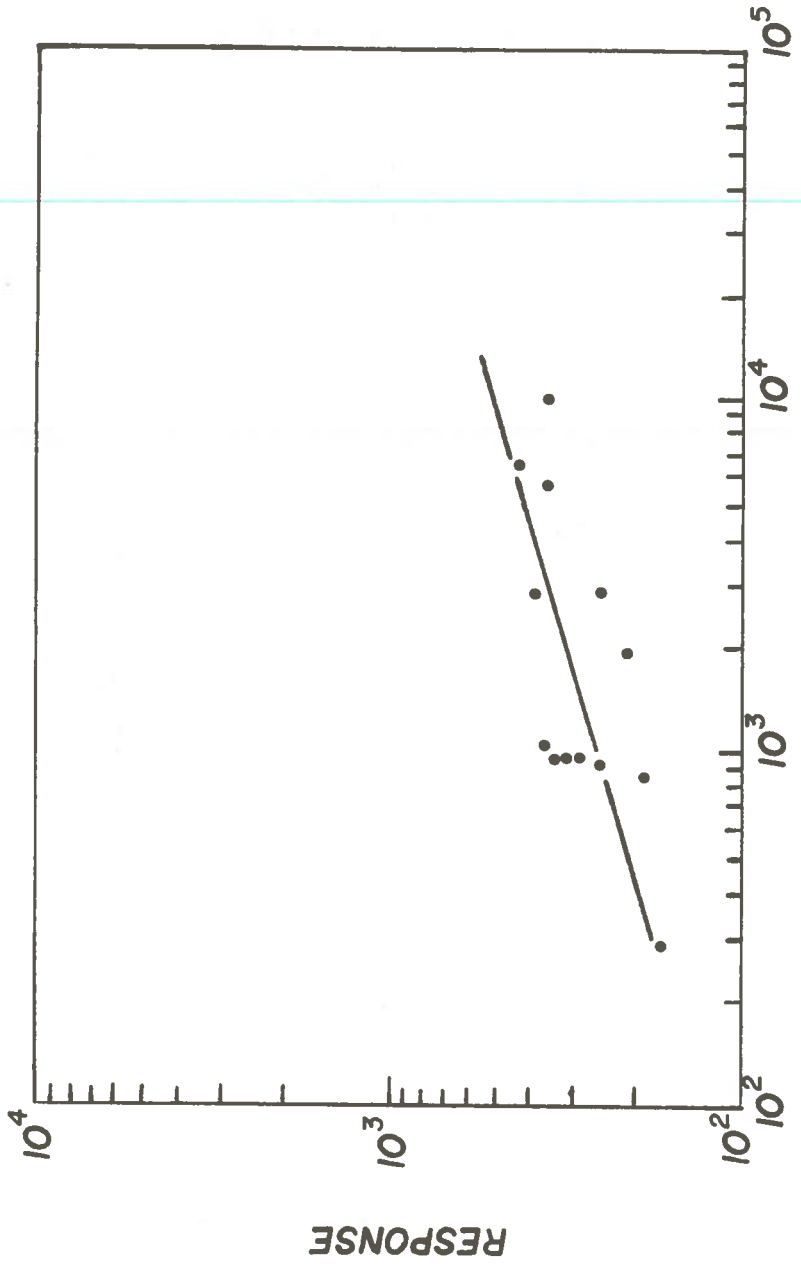

INDICATED DOSE

Figure 3.24  
Plot of Response versus Indicated Dose  
for LiF at 400° C and 2.0 tons

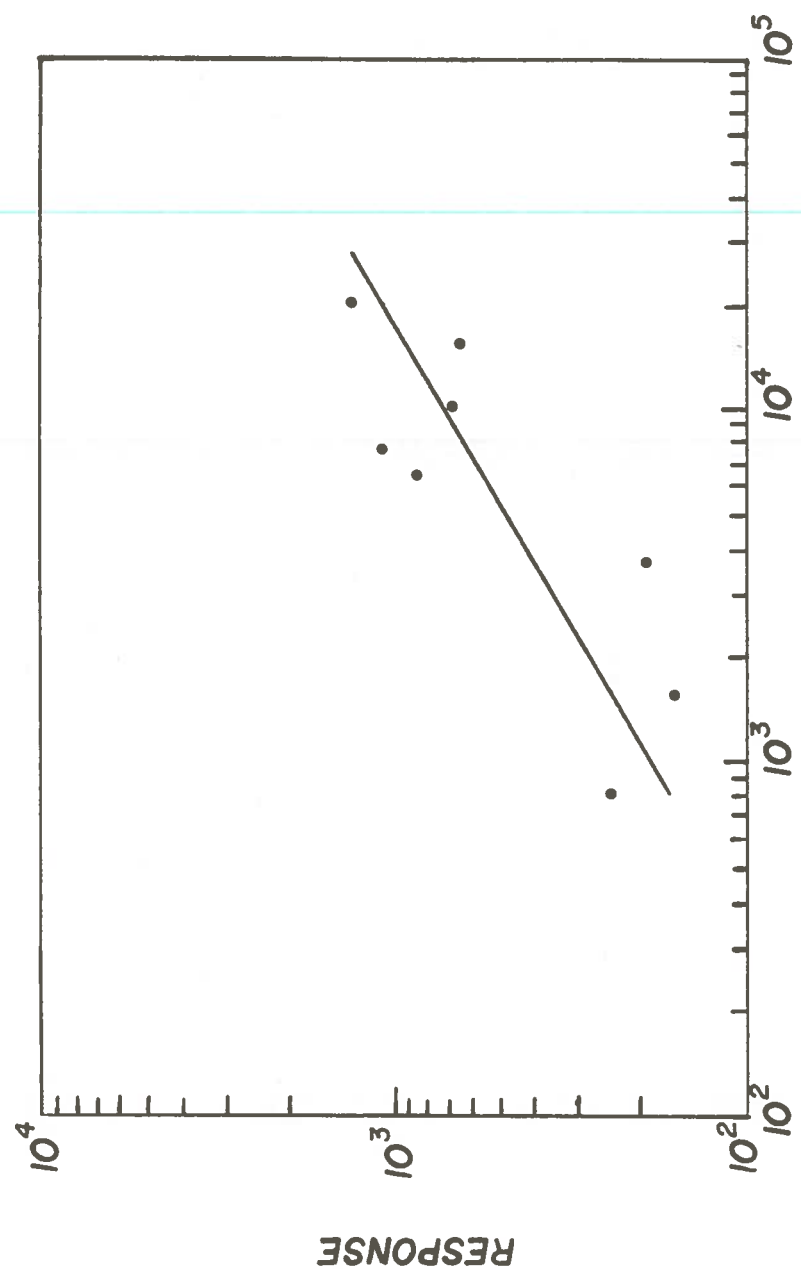

**INDICATED DOSE**

Figure 3.25  
Plot of Response versus Indicated Dose  
for 25% - LiF, 75% - CaF<sub>2</sub> at 300° C and 1.5 tons

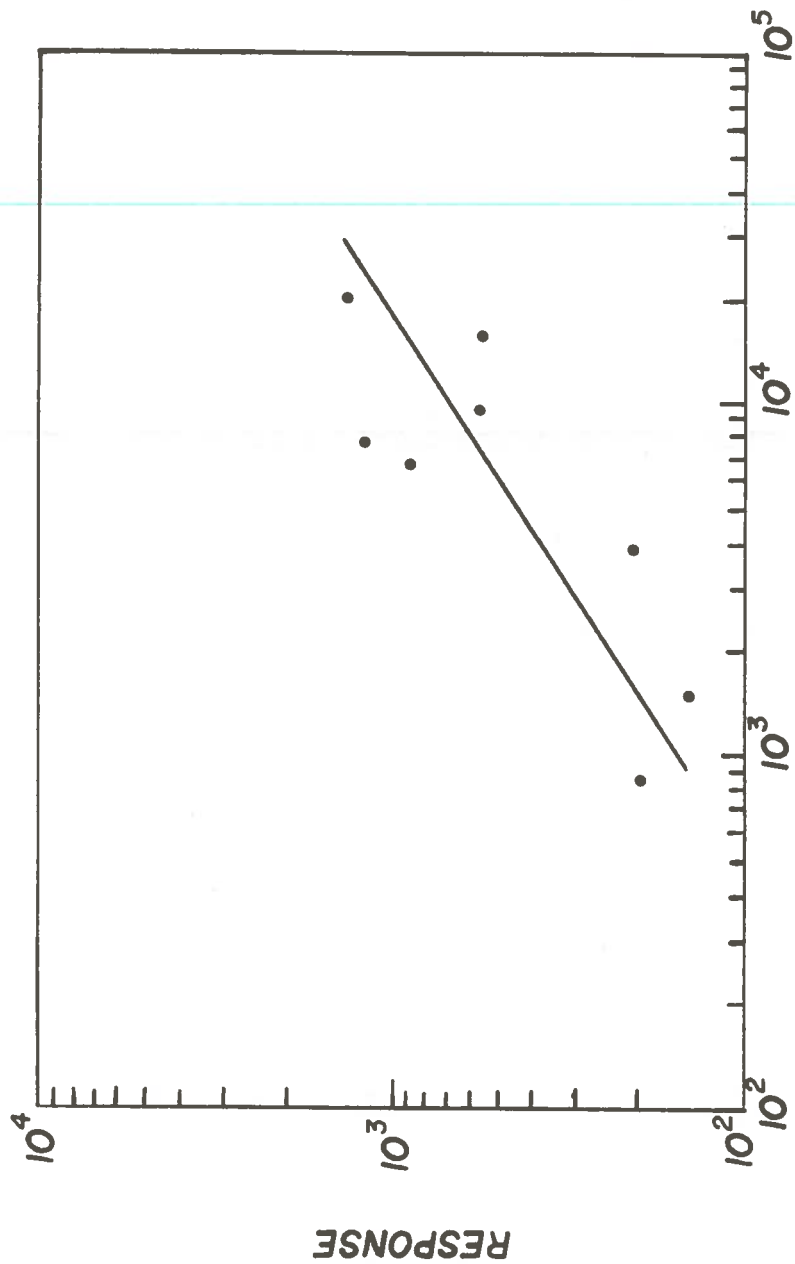

**INDICATED DOSE**

Figure 3.26

Plot of Response versus Indicated Dose  
for 50% - LiF, 50% - CaF<sub>2</sub> at 300° C and 1.5 tons

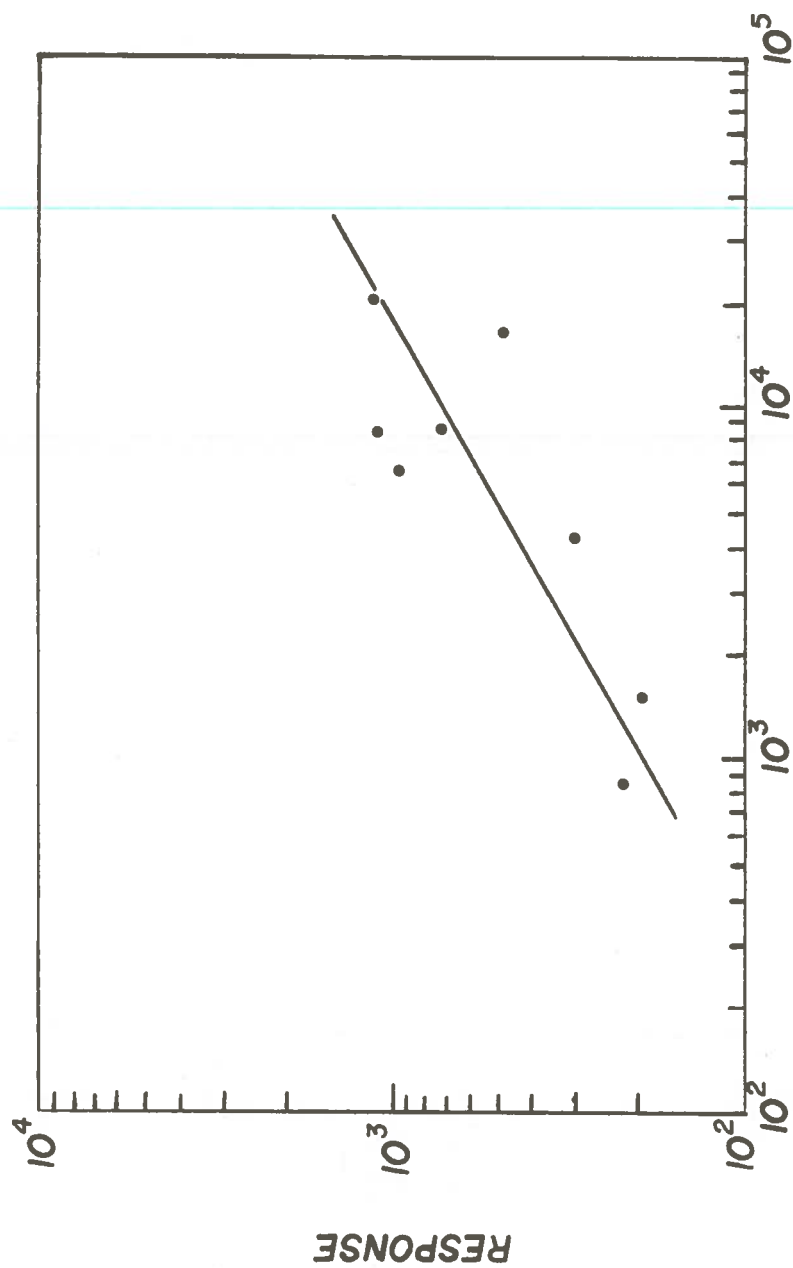

**INDICATED DOSE**

Figure 3.27

Plot of Response versus Indicated Dose  
for 75% - LiF, 25% - CaF<sub>2</sub> at 300° C and 1.5 tons

## CHAPTER IV

## Discussion

Investigation of the feasibility of producing experimental hot-pressed thermoluminescent dosimetry pellets involves a variety of problems. Included among these are determination of optimum pressure and temperature conditions, selection of candidate materials, assurance of contamination-free pressing conditions, evaluation of optimum read-out procedures, and several other minor points. These aspects of feasibility have been investigated and are discussed in the following sections.

Mechanics of Pellet Production

The hot-pressing procedures followed in this study required control over certain physical parameters and material properties. Temperature regulation of the die was accomplished through controlled heating, using a laboratory oven monitored with a thermocouple gauge. When the die was removed from the oven, temperature control and monitoring capabilities were lost which made estimating heat drop due to convection and conduction necessary. An approximation of the temperature drop through convection can be made using the formula:<sup>8</sup>

$$\frac{T - T_{\infty}}{T_i - T_{\infty}} = e^{-(hA_s/mC_p)t},$$

in which:

T = Temperature at time t  
 T<sub>∞</sub> = Ambient temperature  
 T<sub>i</sub> = Initial temperature  
 h = Heat transfer coefficient

A = Surface area  
 m = Mass  
 C<sub>p</sub> = Specific heat  
 t = Delay time

Substituting the appropriate parameters yields a value of the maximum temperature drop expected of 3.3 Celsius degrees for a 20 second period. The heat lost by conduction, during the initial pressure build up is difficult to calculate since the value of the conductive thermal resistance is not easily determined. An estimate of total heat loss can be made, however, by simulating the actual situation. This was accomplished by heating the die body to 300° C, removing it from the oven, and placing it on a metal base plate. A thermometer was then placed in the die bore. The temperature change observed was six Celsius degrees per 20 seconds. This figure, which is the temperature change resulting from both the convective and conductive heat transfer, can be considered a "worst case" example. In actuality, the die assembly was in contact with the press only 10 seconds, which would reduce the observed drop slightly. Nevertheless, the six degree temperature drop translates to only a two per cent deviation in temperature from the time the die is removed from the oven to the point when the desired pressure is attained.

Modifications such as:

1. installing a heating coil around the die,
2. placing a thermocouple within the die, and
3. insulating the top and bottom of the die during pressing  
with asbestos,

would result in more nearly constant temperature during pellet pressing.

Pressure was another physical parameter that required careful control. Fortunately, the hydraulic press used was equipped with a gauge that was

easy to read, so control of the pressure was no problem. Problems did arise initially, however, when the pressures chosen for the experiment resulted in deformation of the plungers. This situation was remedied by lowering the pressures and choosing a superior plunger material.

At first, plungers were machined from mild steel. These were unsatisfactory for two reasons: 1) the steel was too ductile--the plungers would deform under pressure, and 2) the radial tolerances could not be accurately maintained. Drill bit shanks fit the requirements exactly in that they were constructed of carbon or alloy steels, which were much less ductile than mild steel, and the diameter was the correct size. Tests proved drill bit shanks adequate in strength and size but lacking in resistance to oxidation at elevated temperatures. The oxidation of the plunger material could discolor the sample being pressed or destroy the polished finish on the plunger face. In an effort to correct this situation, a set of plungers was chromium plated, and found to be much superior to unplated plungers. Unfortunately, these initial plungers could not be polished since the plate thickness was too small. Polishing was still necessary occasionally, not because of surface oxidation, but because of TLD material that would adhere to the face. A second set of plungers was electroplated with the plating thickness approximately four times that for the initial set. Before use, the plated plunger faces were polished carefully on a polishing wheel, which removed any plating imperfections. This set of plungers was then used successfully at temperature from 200° C to 400° C for the remainder of the experiment. These plungers are not indestructible, however, since chromium does oxidize rapidly at temperatures above 400° C.



### TLD Readout Technique

Since there was no set technique for reading the hot-pressed pellets and the characteristic output was not known, any of the available TLD reader modes could be tried and utilized if found to fit a particular type of TL output. Three options exist on the Victoreen 2800 TLD reader:

1. the  $\text{CaF}_2$  read cycle,
2. the LiF - no anneal cycle, and
3. the LiF - anneal cycle,

---

each especially designed for use with Victoreen hot-pressed chips. The  $\text{CaF}_2$  cycle incorporates a short warm-up period, with a rapid temperature increase to  $355^\circ \text{C}$ . This temperature is maintained for 35 seconds and then decreases to room temperature. The two LiF cycles likewise have the short warm-up period with the temperature increasing to  $255^\circ \text{C}$  and held at that level for 24 seconds. The LiF anneal cycle utilizes a second rapid temperature increase to effectively anneal the commercial chips. Lithium fluoride chips read in this cycle need no further processing before reuse.

A nitrogen purge, which is effective in reducing spurious luminescence, is also available for use during any of these cycles.

Each different type of pellet produced was exposed and read using the cycles mentioned above, both with and without the nitrogen purge. The optimum mode for reading the calcium fluoride pellets was the  $\text{CaF}_2$  cycle. Factory recommended dosimeter factor and high voltage settings were employed for reading TL pellets because of the necessity for simultaneous exposure of both pellets and commercial hot-pressed chips and to expedite reading after exposure. The lithium fluoride and lithium fluoride/calcium fluoride mixture pellets were read with the LiF-anneal

cycle because the  $\text{CaF}_2$  cycle lacks adequate sensitivity. The suggested PMT high voltage setting was used with a dosimeter factor of one. The nitrogen purge option was not used for these or any pellets because the TL output was reduced and the gas flow could not be accurately regulated.

Analog data for  $\text{CaF}_2$ , LiF, and LiF/ $\text{CaF}_2$  mixtures were recorded on a strip chart recorder to allow easy comparison of glow curves and provide a permanent record.

The type of information obtained in this investigation was of two forms: the digital output, displayed directly on the TLD reader, and the glow curve, a plot of TL output versus temperature. The TLD reader's digital output is an integration of the area under a glow curve peak and is the form of TL information most persons are familiar with.

The glow curve, on the other hand, is difficult to interpret without the aid of some type of curve integrator. In this investigation, curve plots were produced only as a qualitative aid in pellet inter-comparison. Curve quality, meaning shape and size, can readily be observed. Typical examples of the types of curves obtained are presented in Figures 4.1 through 4.5. Apparent differences are obvious when contrasting an "ideal" LiF glow curve (Figure 4.1) and the reagent grade LiF pellet output (Figure 4.2). Pellet sensitivity and peak shape are extremely poor in comparison, which could indicate either the use of a poor TL powder, or an inferior pellet configuration. In an attempt to resolve this question, a sample pellet, pressed from TLD 100 powder, was exposed and read. The resulting glow curve, Figure 4.3, is many times superior to the reagent grade pellet, and resembles the output of the

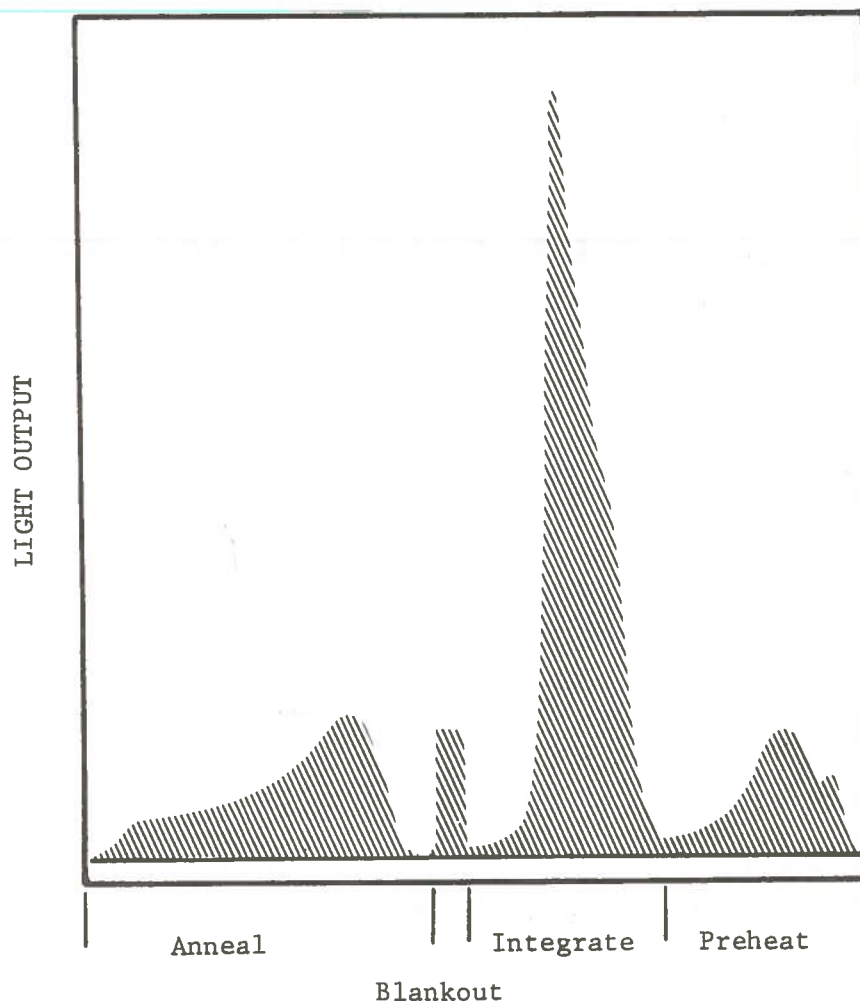

Figure 4.1

Typical Commercial LiF Glow Curve  
(Dose approximately 0.9R)

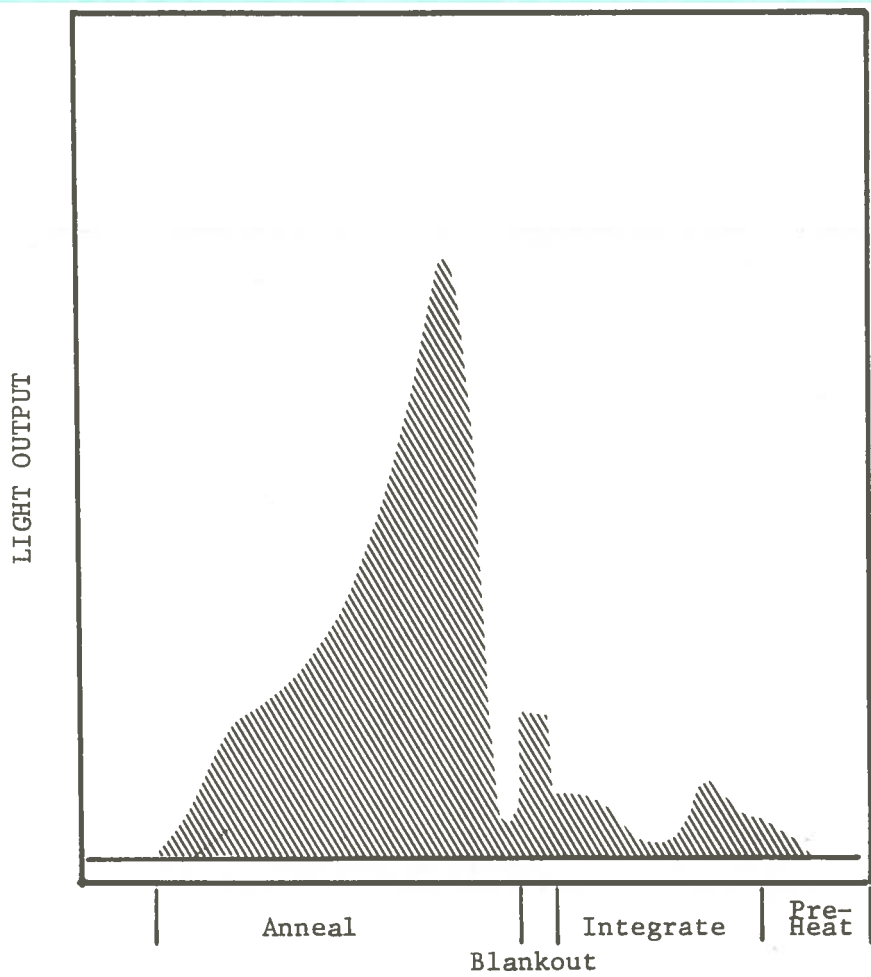

Figure 4.2

Typical LiF Pressed Pellet Glow Curve  
(Dose approximately 8.0R)

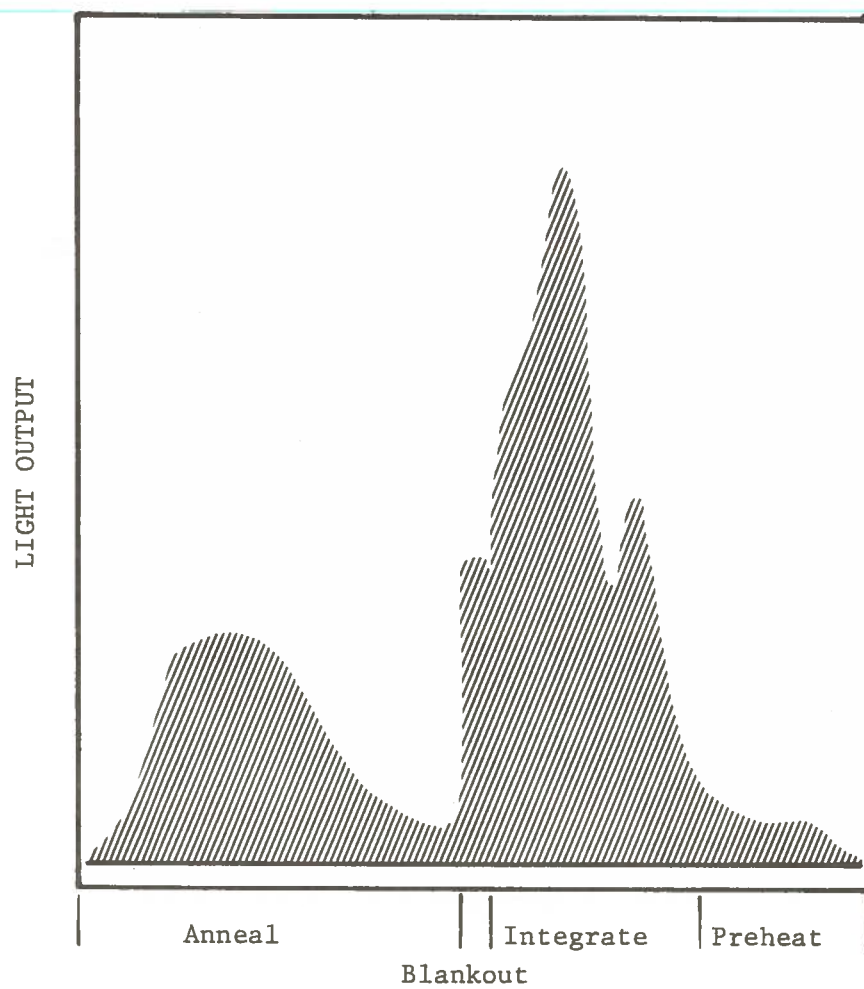

Figure 4.3

Glow Curve from a Pellet  
Pressed from TLD 100 Powder  
(Dose approximately 1.0R)

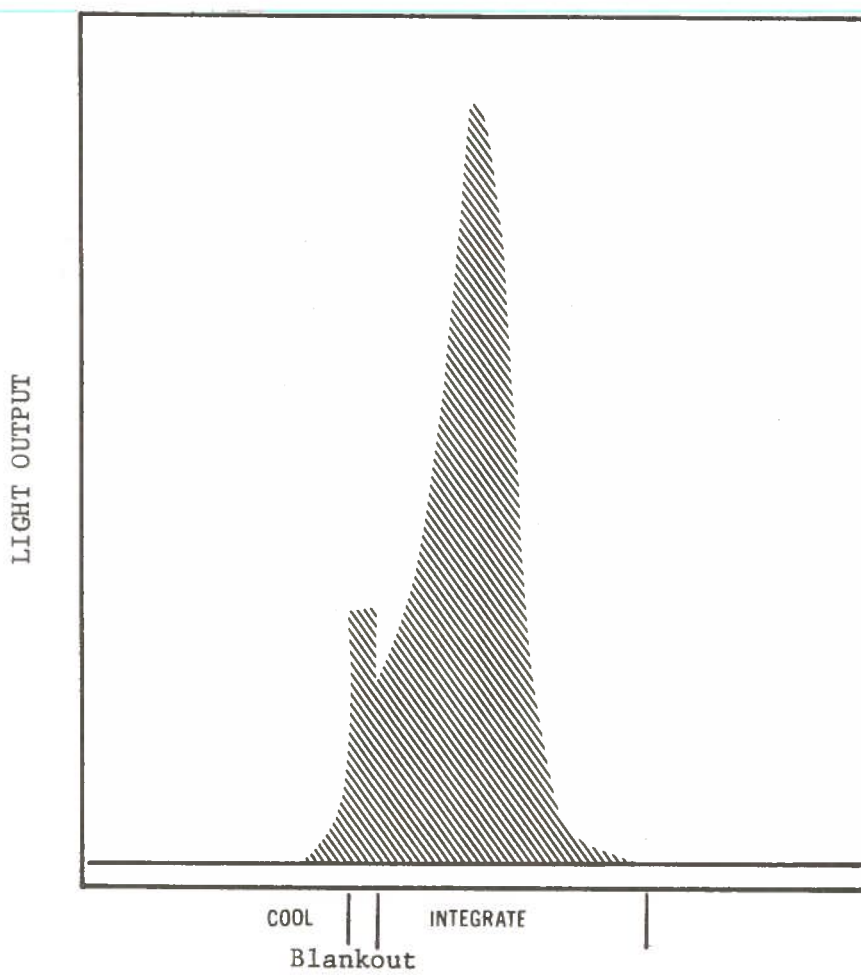

Figure 4.4

Typical  $\text{CaF}_2$  Pressed Pellet  
Glow Curve (Dose approximately 6.0R)

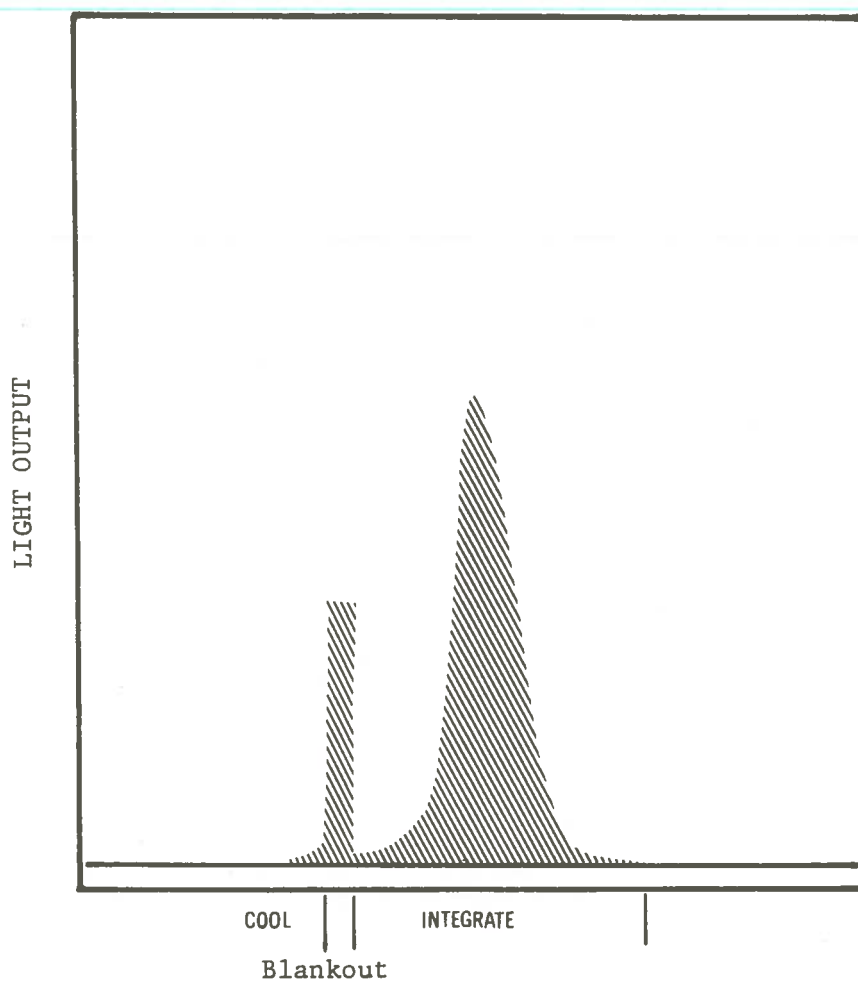

Figure 4.5

Typical Commercial  $\text{CaF}_2$  Glow Curve  
(Dose approximately 1.5R)

commercial grade chip, which suggests that the reagent grade lithium fluoride is an unsatisfactory TL material.

The reagent grade calcium fluoride glow curve, Figure 4.4, shows good sensitivity and peak shape. Comparing Figure 4.4 with Figure 4.5, a typical glow curve from a commercial  $\text{CaF}_2$  chip, one may notice that the peak from the pressed calcium fluoride pellet is shifted slightly to the left, which results in a portion of the curve not being integrated. This, in effect, increases the error involved in low dose measurements, because of the large fraction of the signal lost.

Modifications to the Victoreen 2800 TLD Reader could be made that would result in total calcium fluoride pellet curve integration. Suggested alterations would entail the purchase or construction of an external temperature programmer. This would allow the operator to custom fit a heating program to a variety of different type pellets, and provide the versatility essential to a research instrument.

#### Pellet Radiation Exposure

Several different types of radiation sources are available at the Nuclear Science Center. For the purpose of irradiating the pressed pellets, one must be chosen that will meet the following requirements:

1. it must display good radiation field reproducibility in both intensity and energy,
2. exposure control should be simple, enabling accurate measurement of irradiation times and distances, and
3. use of the source must not endanger persons in the area.

Sources open for consideration are X-ray, Cobalt 60, Iridium 192, and Cesium 137. The use of X-rays can be ruled out directly for failure



to meet requirements one and two, in that, the field energy may vary, the intensity may change, and there is no accurate method of timing an exposure. The isotopic sources, on the other hand, can meet the specified requirements if the source is housed in a radiographic camera and possesses the intensity to provide quick, accurate exposures. Of the three sources listed, Cesium 137 best fit the requirements of this experiment in the areas of source strength and camera design.

The actual exposure of the pellets was discussed previously in Chapter II. It should be stated here, however, that the irradiator cover sheet did provide the necessary equilibrium thickness.

#### Determination of Optimum Pressing Parameters

A selection of any optimum pressing parameters must be based on a consideration of three factors. These include:

1. pellet sensitivity to ionizing radiation,
2. TL output linearity through a specific dose range, and
3. pellet integrity, or its resistance to breaking and chipping.

Pellet sensitivity, or the quantity of TL emission resulting from a certain exposure, should be statistically distinguishable from the background, with a maximum slope for the response-versus-dose curve. In addition, the response-versus-dose plot should be relatively linear if a simple interpretation of the data is to result. Finally, pellet susceptibility to breaking and chipping during day-to-day use must be sufficiently low to avoid wide fluctuation in response caused by a loss of TL material.

Reagent Grade Calcium Fluoride. Figures 4.6, 4.7, and 4.8 are three dimensional plots developed to aid in the determination of the optimum pressing parameters for pellets constructed of reagent grade calcium fluoride. Chip sensitivity is plotted versus pressure and temperature in Figure 4.6. Areas of increased sensitivity are clearly evident in the 150° C and 200° C ranges, with a large peak at 400° C and one ton pressure. A parameter related to "how well a set of points approximate a straight line" was devised by defining a term called the linearity deviation. The definition states that the linearity deviation is the average of the response deviations, where the response deviation is the ratio of expected response and resulting response, or vice versa if the result is less than one. Therefore, the closer the linear deviation is to one, the better the set of points approximate the line. This analysis was applied to the response versus indicated dose plots in Chapter III, and is summarized in the three dimensional representation of deviation versus pressure and temperature in Figure 4.7. Optimum pellet response in this figure occurs at the minimums, mainly in the 200° C to 300° C ranges. Data for Figures 4.6 - 4.8 are presented in Table 4.1.

Since areas of maximum TL output and minimum deviation do not intersect, some compromises apparently need to be made. Figure 4.7, a plot of the ratio of the TL output and deviation versus temperature and pressure, is an attempt to find such a compromise. The area of major consideration, which is lightly shaded in Figure 4.8, are those regions that show the least variation from surface plots in Figures 4.6 and 4.7. Based on this information it can be concluded that a single set of ideal pressing parameters do not exist. Rather, there is a wide range of possible values that will yield fairly good results.

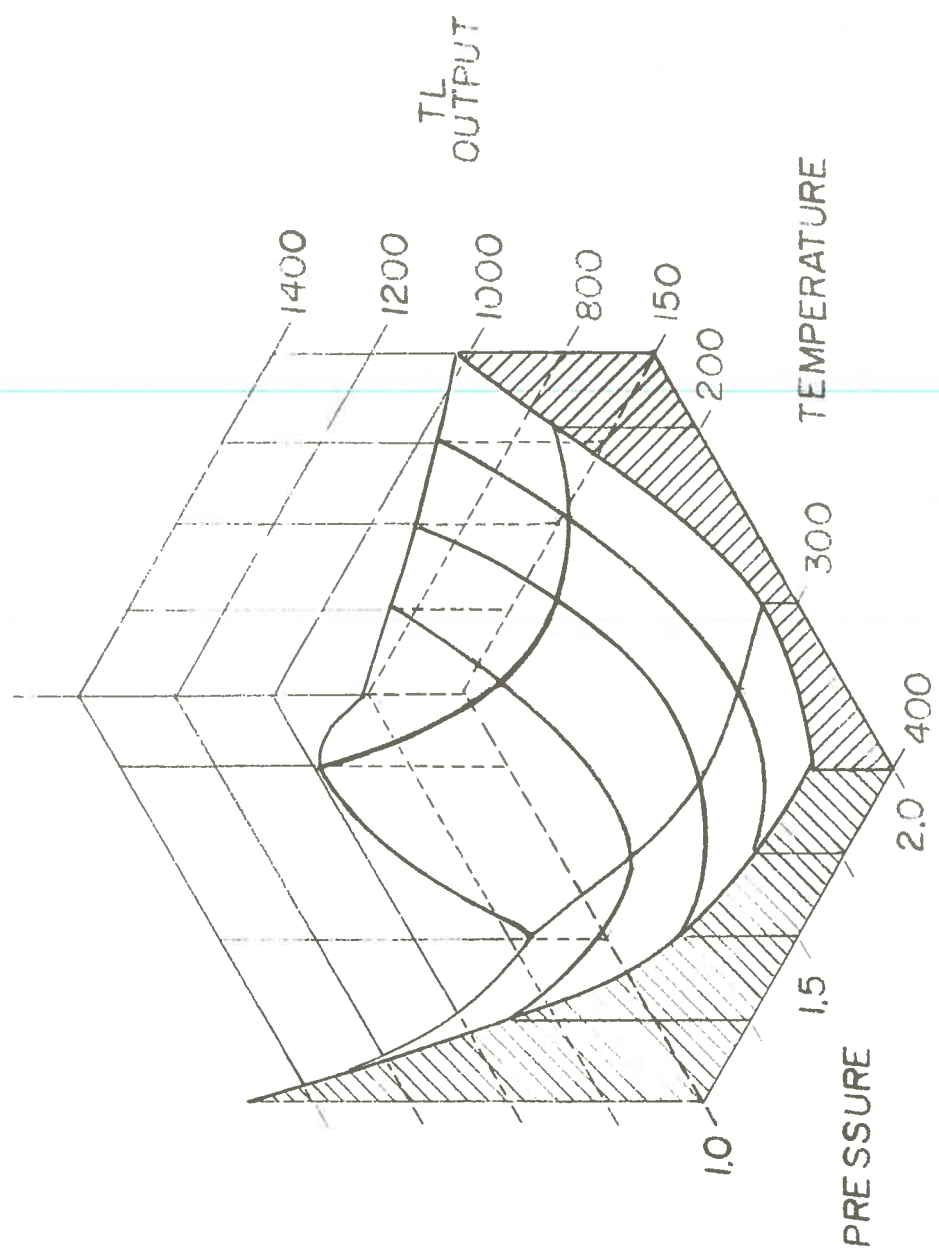

Figure 4.6  
Three dimensional plot of TL output versus  
temperature and pressure

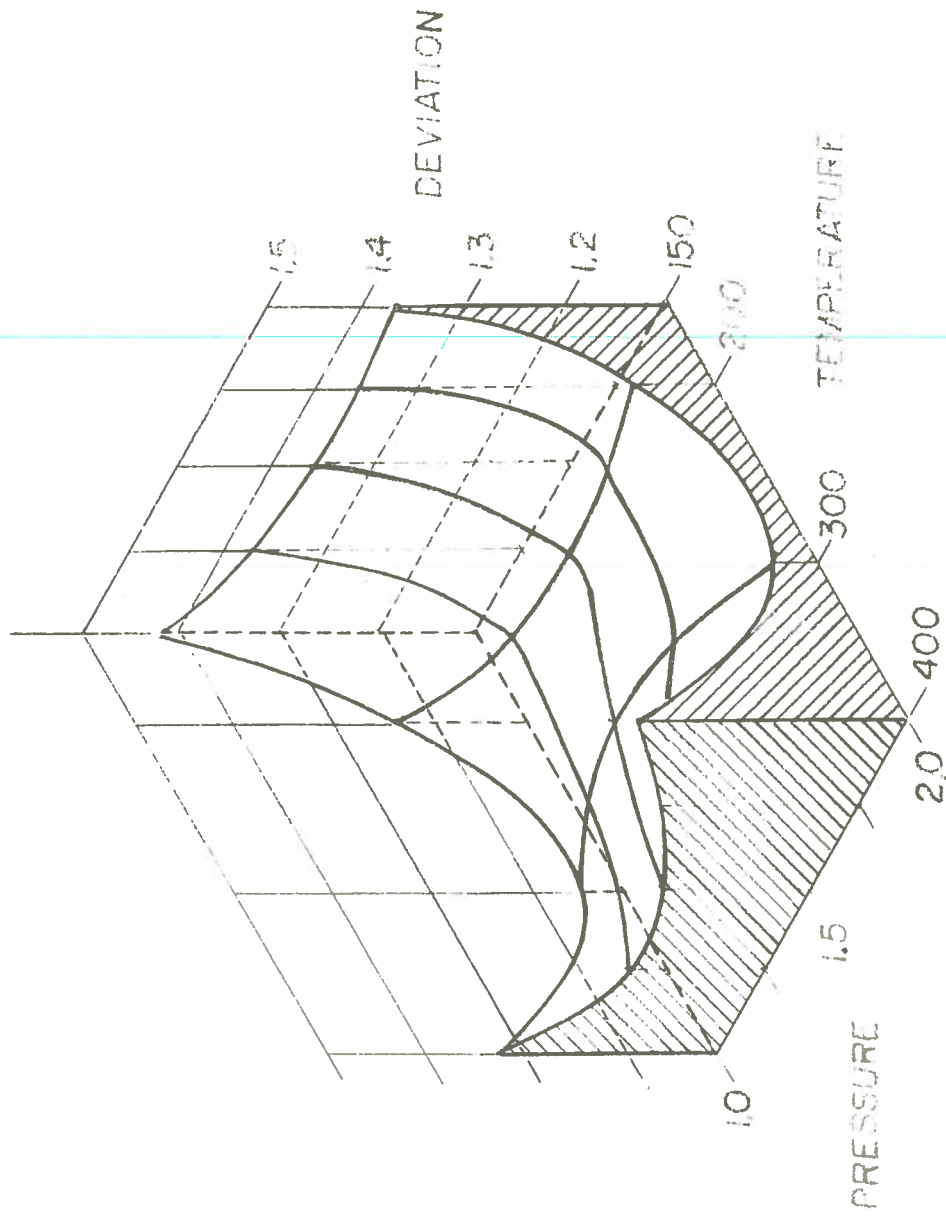

Figure 4.7

Three dimensional plot of linear deviation versus temperature and pressure

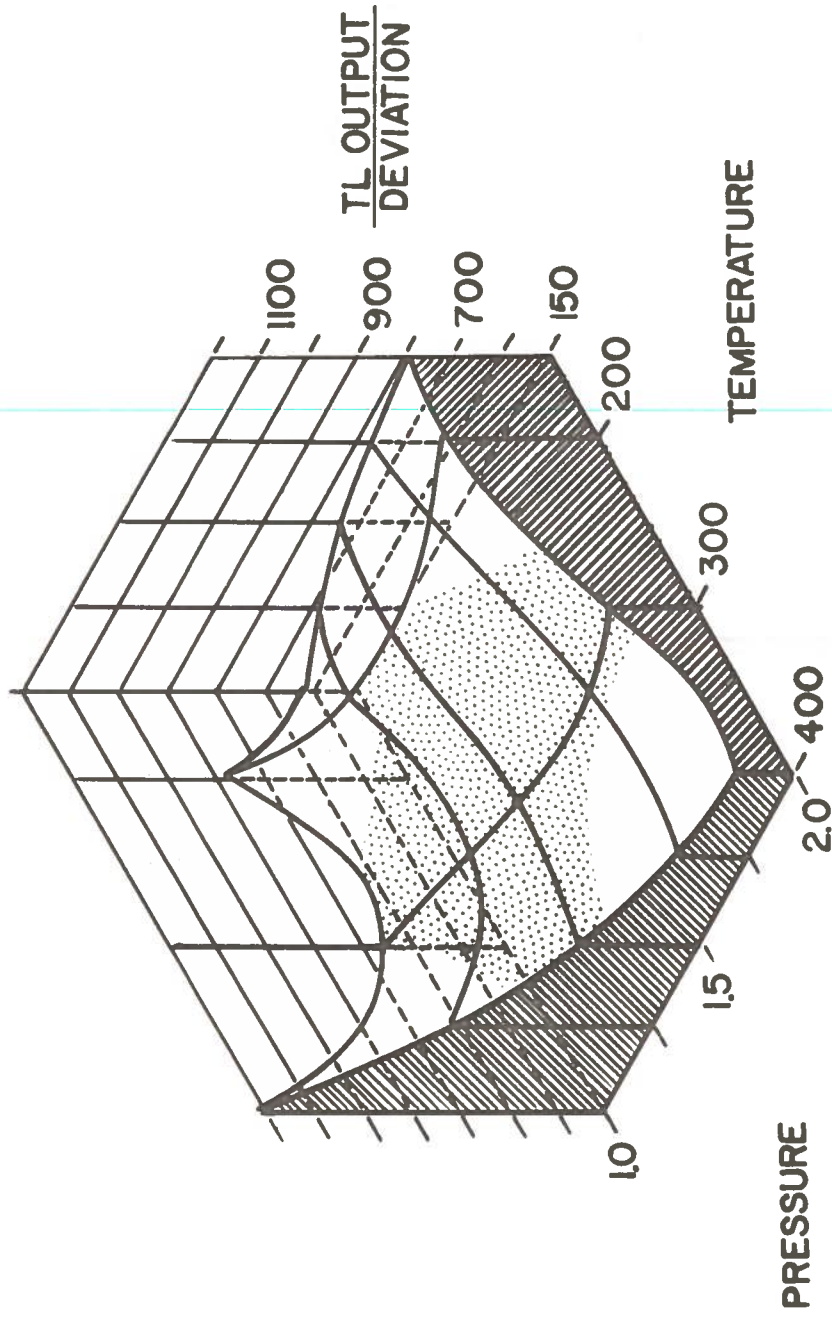

Figure 4.8

Three dimensional plot of TL output/linear deviation vs. temperature and pressure

TABLE 4.1

A List of Data Plotted in  
Figure 4.6, Figure 4.7, and Figure 4.8

<u>Temperature</u>	<u>Pressure</u>	<u>Linearity Deviation</u>	<u>TL Output @ 5,000 mR</u>	<u>TL/Deviation</u>
150	1.0	1.44	900	625
150	1.5	1.36	1,000	735
150	2.0	1.38	1,100	797
200	1.0	1.25	1,100	880
200	1.5	1.14	800	702
200	2.0	1.19	1,000	840
300	1.0	1.14	850	745
300	1.5	1.21	700	625
300	2.0	1.11	750	676
400	1.0	1.35	1,650	1,222
400	1.5	1.26	950	754
400	2.0	1.38	850	615

Pellet integrity was only qualitatively observed during this investigation because no quantitative procedure was devised. Observations seemed to indicate that pellets produced at low pressures and temperatures are more susceptible to breakage and chipping at the edges than those pellets produced at higher temperatures and pressures. This seemed to coincide with increases in pellet density as might be expected. (Table 4.2) These observations held true not only for the calcium fluoride pellets, but for the other types of pellets as well. Semi-quantitative information might have been obtained had the pellets been weighed after each use so that changes in weight could have been noted. Data of this nature could further reduce the range of desirable pressing values.

Reagent Grade Lithium Fluoride and Lithium Fluoride/Calcium Fluoride

Mixture Pellets. Pellets constructed of lithium fluoride exhibited poor pellet sensitivity and response linearity. Lithium fluoride/calcium fluoride mixture pellets display no enhancement because of the combination of TL material; in fact, the lithium fluoride served as nothing more than an inert diluent. In view of these results, a detail analysis was not performed as with the calcium fluoride.

The change in relative response with mixture composition is presented in Figure 4.9. These responses are for a constant dose of  $10^4$  rads.

TABLE 4.2

## Calcium Fluoride and Lithium Fluoride Pellet Densities

## Calcium Fluoride

<u>Temperature</u>	<u>Density gm/cm<sup>3</sup></u>			
	Pressure; tons:	<u>1.0</u>	<u>1.5</u>	<u>2.0</u>
150° C		1.833	1.879	2.033
200° C		1.972	2.046	2.061
300° C		2.021	2.162	2.174
400° C		2.311	2.375	2.467

## Lithium Fluoride

<u>Temperature</u>	<u>Density gm/cm<sup>3</sup></u>			
	Pressure; tons:	<u>1.0</u>	<u>1.5</u>	<u>2.0</u>
150° C		1.982	2.007	2.219
200° C		2.117	2.198	2.165
300° C		2.152	2.214	2.201
400° C		2.369	2.411	2.415



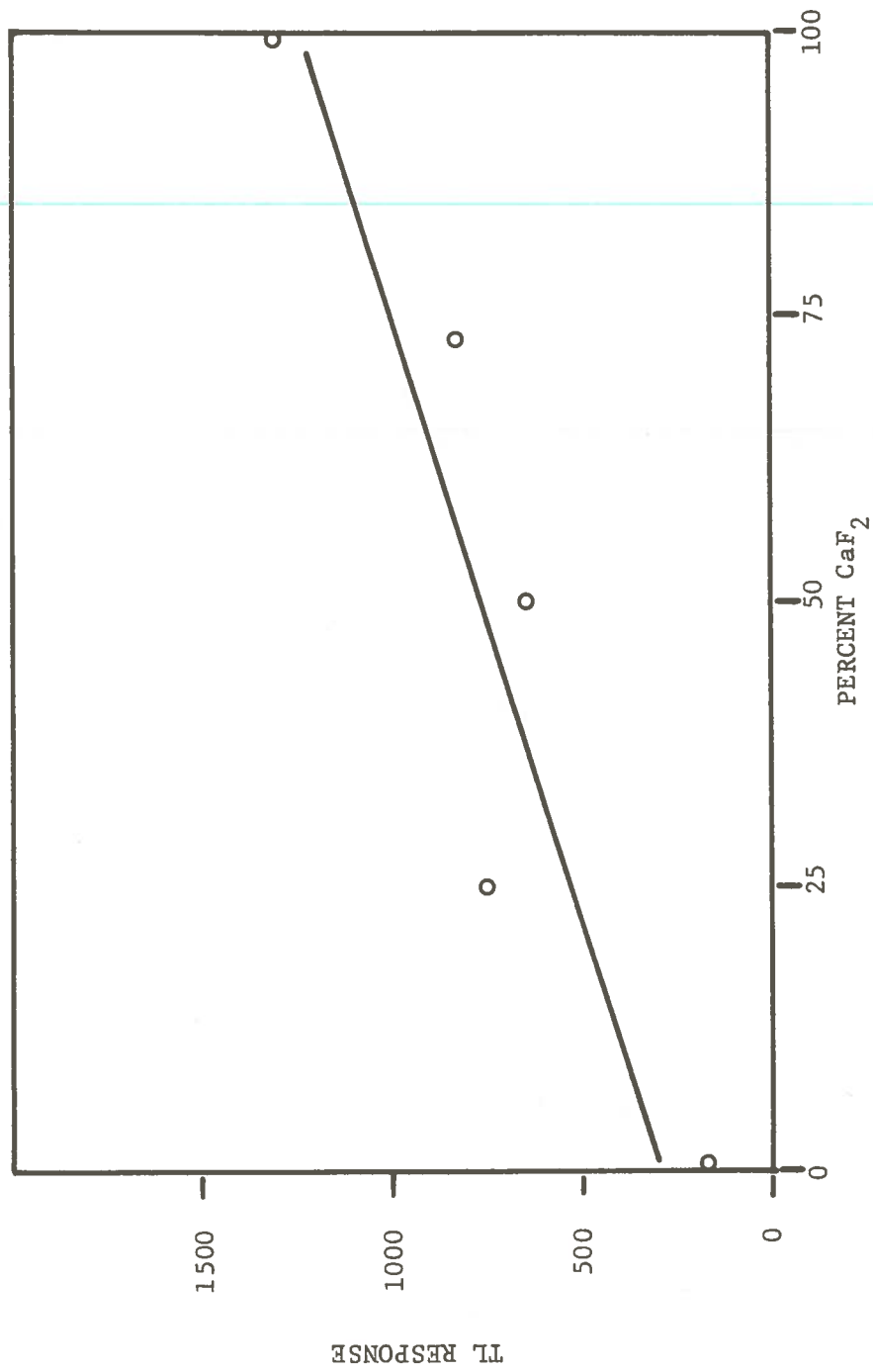

Figure 4.9  
TL Response Variation as a Function of  
LiF/CaF<sub>2</sub> Mixture Composition

## CHAPTER V

## Conclusions

This investigation was designed to determine the feasibility of constructing special TLD materials. Feasibility, however, can only be ascertained after a review of the results and accomplishments of this study.

From the beginning, one of the main objectives of this investigation was the production of TLD pellets from powder that would maintain their integrity reasonably well during normal use. This was achieved through the design and fabrication of a die assembly, and the use of an oven and hydraulic press.

Calcium fluoride, lithium fluoride and combinations of both reagent grade materials were used in the attempt to produce a pellet which might display useful TL properties. Lithium fluoride and lithium fluoride/calcium fluoride mixtures are not suited for this purpose because of an insufficient sensitivity to ionizing radiation, which is consistent with the observations made by Cameron.<sup>9</sup> Calcium fluoride, on the other hand did display somewhat desirable sensitivity and response characteristics which would allow its use as a TLD material. Satisfactory reproducibility can be achieved if the pellets have been fabricated within the range of recommended pressing parameters and the doses received are above 1 R. In the sub-R range, however, wide data scatter would preclude the use of these pellets, primarily because of two problems: 1) non-radiation induced thermoluminescence (triboluminescence in this case), and 2) a

mismatching of the TLD Reader read cycle program with the pellet TL response.

The triboluminescence effect can be significantly reduced through the use of a vacuum pick-up mechanism for handling. Specific investigations into the nature of the triboluminescence might lead to techniques for surface passivation that would also significantly reduce spurious handling effects.

The obvious solution for the read cycle mismatch is the fabrication or purchase of an external temperature programmer. This will allow custom fitting of a heating program to the unique output of a variety of different pellet types.

The procedures and techniques developed during this work, and modified as suggested in the preceding discussion, establish the practical capability of hot pressing special TL materials for research applications. Failure to produce successful LiF pellets from "off-the-shelf" reagent indicates the necessity for chemical modification of this material, and suggests that other candidate materials might also require such modification.

## REFERENCES

1. Becker, K., Solid State Dosimetry, CRC Press, Cleveland, 1973.
2. Cameron, J. R., Thermoluminescent Dosimetry, University Press, Milwaukee, 1968.
3. Curie, M., Research on Radioactive Substances, Gauthier-Villars, Paris, 1904, p. 105.

---

4. Wick, F. G., "The Effect of X-Rays in Producing and Modifying Thermoluminescence", Physics Review, Vol. 25, 1925, p. 588.
5. Lyman, T., "The Transparency of the Air Between 1100 and 1300 A", Physics Review, Vol. 48, 1935, p. 149.
6. Daniels, F., "Thermoluminescence and Related Properties of Crystals", Presented at the Symposium on Chemistry and Physics of Radiation Dosimetry, 1950, Technical Command, Army Chemical Center, Maryland.
7. Cameron, op. cit.
8. Krieth, F., Principles of Heat Transfer, Intext Education Publishers, New York, 1973.
9. Cameron, op. cit.

## VITA

Russell T. Kracht was born on November 22, 1951, in St. Louis, Missouri. He attended Robert E. Lee High School in Baton Rouge, Louisiana and graduated in 1969.

In 1969 he entered Louisiana State University and graduated in December, 1973 with a B.S. in Mechanical Engineering. He subsequently entered graduate school in Nuclear Engineering at LSU. At that time, he received a graduate assistantship in the Nuclear Science Center. He has worked in the area of health physics with Dr. Robert C. McIlhenny and Mr. Jack Evans.

He is presently a candidate for the degree of Master of Science in the Department of Nuclear Engineering.